



# General Catalogue



Presence Detection  
Motion Detection  
Lighting with Detection

26

Automation and Comfort for Efficient Lighting and Security



Choose the most suitable solution to achieve optimum efficiency in just 3 steps:

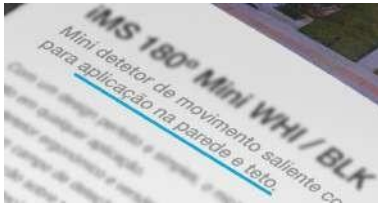

1

### Place of Application

Ceiling | Wall | Corner | Surface | Built-in



2

### Functionality

Motion Detector | Presence Detector | Twilight photocell | Lighting with detection, etc...

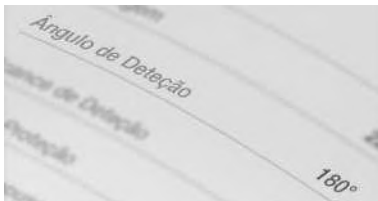

3

### Detection Angle

360° | 270° | 200° | 180° | 120° | etc...



4

### QR Codes

Direct access to the relevant page on the website (Technical Data Sheets, Instruction Manuals, etc.)



5

### EAN Codes

Various features, such as checking stock levels via a picking system, if your company has such a system in place.



BYiMSENS® is a European brand specialising in lighting automation, smart detection and energy efficiency solutions, developed by Pronodis – Soluções Tecnológicas, Lda, a company founded in 2005 with extensive experience and in-depth knowledge of the electrical and technology markets. We are guided by our motto:

We are in the driving seat!  
On the road to success! Ours and yours!

Following several years of growth and consolidation within the sector, the BYiMSENS® brand (iMSENS® and iMTOOLS®) was launched in April 2017, created to meet the growing demands of the automation and energy efficiency market.

BYiMSENS® is the result of a combination of technical expertise, an understanding of market needs and specialist know-how in sensors and smart control systems. The brand focuses on the detection, automation and efficient management of lighting, positioning itself as a technical leader in the smart lighting sector in Portugal and across Europe.

Unlike generalist brands, BYiMSENS® does not seek to sell “everything”. Its specialisation in infrared sensors, high frequency technology, presence detection, DALI2 control, Bluetooth and integration with BMS systems enables it to establish itself as a highly technical, modern brand focused on highly reliable professional solutions.

It stands out for its quality, original design, registered moulds, technical precision and continuous product development. At the same time, it presents itself as a competitive alternative to major European brands, offering advanced technology, professional performance and excellent value for money.

It is strongly committed to innovation and in-house development, with an internal product development department and solutions designed to meet the real needs of installers, distributors, designers and end users. This close connection to the market enables the creation of functional, efficient products tailored to the specific requirements of modern construction.

The trust it has earned among installers, electricians and electrical equipment distributors stems from its ease of installation, robustness, responsive technical support and proven reliability on site. It has thus become a trusted partner for residential, commercial, hospitality, office and smart building projects.

It stands out for its rapid technical response and its ability to adapt to the standards and specific needs of the global market.

Quality is a core value of the brand and is evident at every stage of the process — from design and engineering to the technology and final functionality of the products. In addition to quality, the brand stands out for its flexibility, sustainability, wide range of solutions and ability to always offer the ideal product for every application, delivering added value in terms of energy efficiency and cost-effectiveness.

Mindful of its environmental and social responsibilities, the company continually seeks to develop sustainable, efficient solutions that meet the latest energy and technological requirements of the European market.

Today, BYiMSENS® continues to grow alongside its distributors, partners and customers, establishing itself as a technical, reliable and pragmatic brand, ready to meet the challenges of modern automation with innovation, a customer-focused approach and a forward-looking vision.

Visit our website at [www.byimsens.com](http://www.byimsens.com) and find out a bit more about us!



























**Automation and Comfort for Efficient Lighting and Security**

+351 234 484 032 (call to a national landline)

[byimsens@byimsens.com](mailto:byimsens@byimsens.com)

[www.byimsens.com](http://www.byimsens.com)

## Pictogram Legend

	Max. Power for Incandescent Bulbs		Acoustic Detection
	Max. Power for Energy-Saving and LED Bulbs		Proximity Sensor
	Detection Angle	<b>IP</b>	Type of Protection
	PIR Motion Detection Range – wall-mounted installation		Impact protection - IK
	PIR Motion Detection Range – ceiling-mounted installation		Command Included
	PIR Motion Detection Range – installation in a corridor		BYIMSENS® APP
	HF Motion Detection Range – ceiling-mounted		Insulation Class I
	PIR Presence Detection Range – ceiling-mounted installation		Insulation Class II
	Effective HF Presence Detection Range – ceiling-mounted		Insulation Class III
	Time Regulation	<b>PMMA</b>	Acrylic or polymethyl methacrylate
	Twilight Regulation	<b>PC</b>	Polycarbonate
<b>LM</b>	Luminous flux – Lumens	<b>ABS</b>	ABS
<b>K</b>	Colour temperature – Kelvin	<b>DALI-2</b>	Device with DALI interface
	Infrared Detection	<b>KNX</b>	Device with KNX interface
	High-frequency Detection		Setting the Lighting Colour
	Twilight Photocell		DIM

## Contents

Matrix.....6

### 01| PIR Motion Detectors

iMS 180° Mini WHI – 818409 V2.....10  
 iMS 180° Mini BLK – 072396 V2 .....10  
 iMS 360° Emb Plan WHI - 072174 V3.....12  
 iMS 360° Emb Plan BLK - 072976.....12  
 iMS 360° Mini Emb Plan WHI - 072389.....14  
 iMS Multi 360° Micro Emb WHI - 072525 .....16  
 iMS 180° Emb WHI - 072419 .....18  
 iMS 200° AP/UP IP65 WHI - 072655 C.....20  
 iMS 360° Micro WHI - 072143.....22  
 iMS 360°-1 WHI - 072624.....24  
 iMS 360°-1 BLK - 072983.....24  
 iMS Multi 360° WHI - 072433.....26  
 iMS M4-3 360° WHI - 818454.....28  
 iMS M4-Corridor WHI - 072334 iC.....30  
 iMS M4-2 200°/360° WHI - 072631 C.....32  
 iMS Multi 270/360 WHI - 072426 V2 C.....34  
 iMS Multi 270/360 BLK - 072457 V2 C .....34  
 iMS Multi Corridor WHI - 072648 .....36  
 iMS Multi-3 360° WHI - 072471 V2 C.....38

### 02| High-Frequency Motion Detectors

iMS 360° HF Int WHI - 818485 .....42  
 iMS M4-HF 360° WHI - 072167 .....44

### 03| Presence Detectors

iMS M4-4 360° Presence WHI - 818461 iC .....48  
 iMS Multi-4 360° Presence WHI - 072488 iC.....50  
 iMS Multi 360° HF Effective Presence WHI - 072808 .....52  
 iMS Multi-4 360° DualTech Presence WHI – 072495 iC...54  
 iMS Multi-3 360° 0-10V Dim Presence WHI - 072815 C.56  
 iMS Multi-3 360° Dali2 APC Presence WHI – 072501C...58  
 iMS Multi 360° Dali2 APC Mini Presence WHI – 072622  
 iC.....60  
 iMS Multi-4 360° KNX Presence WHI - 072000.....62

### 04| Proximity Sensors

iMS Proxim Sensor ON/OFF WHI - 072358 .....66

### 05| Twilight Photocells

iMS Alpha Twilight WHI - 818478.....70  
 iMS Alpha Twilight BLK - 072402 .....70  
 iMS Alpha Twilight Time WHI - 072532 .....72

### 06| Lighting with a PIR sensor

iMSL 360° Urano Led 20W WHI - 072341 .....76  
 iMSL 360° Multi Downlight Sol 18W  
 WHI / BLK / SIL - 072518.....78

### 07| Lighting with a High Frequency sensor

iMSL 360° Neptuno Led 13W WHI - 072105 .....82  
 iMSL 360° Venus E27 PMMA WHI - 818423 .....84  
 iMSL Multi Ceres 12W -> 25W CCT PMMA WHI –  
 072679.....86

### 08| Projectors with and without sensors

iMSL Eris Led 10W WHI - 072129 .....90  
 iMSL Eris Led 10W BLK - 072136 .....90  
 iMSL Saturno Led 20W WHI - 072013 APP .....92  
 iMSL Saturno Led 20W BLK - 072020 APP .....92  
 iMSL Saturno Led 30W WHI - 072037 APP .....92  
 iMSL Saturno LED 30W BLK - 072044 APP .....92  
 iMSL Multi Mercury 20W WHI - 072549 V2 .....94  
 iMSL Multi Mercury 20W BLK - 072556 V2.....94  
 iMSL Multi Mercury 30W WHI - 072563 V2 .....94  
 iMSL Multi Mercury 30W BLK - 072570 V2.....94  
 iMSL Multi Mercury 50W WHI - 072587 V2.....94  
 iMSL Multi Mercury 50W BLK - 072594 V2.....94  
 iMSL Multi Mercury 100W WHI - 072822.....94  
 iMSL Multi Mercury 100W BLK - 072839 .....94  
 iMS 160° Multi Mercury WHI – 072600.....98  
 iMS 160° Multi Mercury BLK – 072617.....98

### 09| Highbay Lighting

iMSL Multi Earth 90W -> 150W BLK - 072723 .....102  
 iMS 360° Multi Earth WHI - 072730 iC .....104

### iMTOOLS Catalogue

iMT AG 2000 - 072181 .....108  
 iMT AG 2000 E - 072198 .....110  
 iMT AG 2000 LCD - 072204.....112  
 iMT GG 100 - 072297.....114  
 iMT CS 3.6V KIT - 072372 .....116

### NIKO Catalogue.....119

This catalogue has been compiled based on the technical specifications currently available; these are subject to change without notice. For further details, please refer to the online technical data sheets. Information is correct except for typographical errors.

## Matrix

Code	Item Description	Category	Page
072000	iMS Multi-4 360° KNX Presence WHI	Presence Detectors	62-63
072013 APP	iMSL Saturno Led 20W WHI	Projectors with and without sensors	92-93
072020 APP	iMSL Saturno Led 20W BLK	Projectors with and without sensors	92-93
072037 APP	iMSL Saturno Led 30W WHI	Projectors with and without sensors	92-93
072044 APP	iMSL Saturno Led 30W BLK	Projectors with and without sensors	92-93
072105	iMSL 360° Neptuno Led 13W WHI	Lighting with a high-frequency sensor	82-83
072129	iMSL Eris Led 10W WHI	Projectors with and without sensors	90-91
072136	iMSL Eris Led 10W BLK	Projectors with and without sensors	90-91
072143	iMS 360° Micro WHI	PIR Motion Detectors	22-23
072167	iMS M4-HF 360° WHI	High-Frequency Motion Detectors	44-45
072174 V3	iMS 360° Emb Plan WHI	PIR Motion Detectors	12-13
072181	iMT AG 2000	Heat Guns	108-109
072198	iMT AG 2000 E	Heat Guns	110-111
072204	iMT AG 2000 LCD	Heat Guns	112-113
072211	iMT AG Scraping accessory kit	Accessory for Heat Guns	108-113
072228	iMT AG Scraper	Accessory for Heat Guns	108-113
072235	iMT AG Stainless iron reflector nozzle	Accessory for Heat Guns	108-113
072242	iMT AG Surface nozzle	Accessory for Heat Guns	108-113
072259	iMT AG Reducer nozzle 9mm	Accessory for Heat Guns	108-113
072266	iMT AG Slot nozzle 9mm	Accessory for Heat Guns	108-113
072273	iMT AG Welding nozzle	Accessory for Heat Guns	108-113
072280	iMT AG Stainless steel reflector nozzle	Accessory for Heat Guns	108-113
072297	iMT GG 100	Glue Gun	114-115
072303	iMT GG Nozzle 3mm diam   5cm long	Accessory for Glue Gun	115
072310	iMT GG Nozzle 2mm diam   4.5cm long	Accessory for Glue Gun	115
072327	iMT GG Glue sticks 11.2mm diam   20cm long   1Kg	Accessory for Glue Gun	115
072334 iC	iMS M4-Corridor WHI	PIR Motion Detectors	30-31
072341	iMSL 360° Urano Led 20W WHI	Lighting with a PIR sensor	76-77
072372	iMT CS 3.6V KIT	Screwdriver	116-117
072358	iMS Proxim Sensor ON/OFF WHI	Proximity Sensors	66-67
072389	iMS 360° Mini Emb Plan WHI	PIR Motion Detectors	14-15
072396 V2	iMS 180° Mini BLK	PIR Motion Detectors	10-11
072402	iMS Alpha Twilight BLK	Twilight Photocells	70-71
072419	iMS 180° Emb WHI	PIR Motion Detectors	18-19
072426 V2 C	iMS Multi 270/360 WHI	PIR Motion Detectors	34-35
072433	iMS Multi 360° WHI	PIR Motion Detectors	26-27
072457 V2 C	iMS Multi 270/360 BLK	PIR Motion Detectors	34-35
072471 V2 C	iMS Multi-3 360° WHI	PIR Motion Detectors	38-39
072488 iC	iMS Multi-4 360° Presence WHI	Presence Detectors	50-51

## Matrix

Code	Item Description	Category	Page
072495 iC	iMS Multi-4 360° DualTech Presence WHI	Presence Detectors	54-55
072501 C	iMS Multi-3 360° Dali2 APC Presence WHI	Presence Detectors	58-59
072518	iMSL 360° Multi Downlight Sol 18W WHI / BLK / SIL	Lighting with a PIR sensor	76-77
072525	iMS Multi 360° Micro Emb WHI	PIR Motion Detectors	16-17
072532	iMS Alpha Twilight Time WHI	Twilight Photocells	72-73
072549 V2	iMSL Multi Mercury 20W WHI	Projectors with and without sensors	94-95
072556 V2	iMSL Multi Mercury 20W BLK	Projectors with and without sensors	94-95
072563 V2	iMSL Multi Mercury 30W WHI	Projectors with and without sensors	94-95
072570 V2	iMSL Multi Mercury 30W BLK	Projectors with and without sensors	94-95
072587 V2	iMSL Multi Mercury 50W WHI	Projectors with and without sensors	94-95
072594 V2	iMSL Multi Mercury 50W BLK	Projectors with and without sensors	94-95
072600	iMS 160° Multi Mercury WHI	Projectors with and without sensors	98-99
072617	iMS 160° Multi Mercury BLK	Projectors with and without sensors	98-99
072624	iMS 360°-1 WHI	PIR Motion Detectors	24-25
072631 C	iMS M4-2 200°/360° WHI	PIR Motion Detectors	32-33
072648	iMS Multi Corridor WHI	PIR Motion Detectors	36-37
072655 C	iMS 200° AP/UP IP65 WHI	PIR Motion Detectors	20-21
072662 iC	iMS Multi 360° Dali2 APC Mini Presence WHI	Presence Detectors	60-61
072679	iMSL Multi Ceres 12W -> 25W CCT PC WHI	Lighting with a high-frequency sensor	86-87
072709	iMS RC3	Accessory for detectors	20-21, 30-35, 38-39,48-51
072716	iMS RC4	Accessory for detectors	54-55
072723	iMSL Multi Earth 90W ->150W BLK	Highbay lighting	102-103
072730 iC	iMS 360° Multi Earth WHI	Highbay lighting	104-105
072747	iMS RC5	Accessory for detectors	104-105
072808	iMS Multi 360° HF Effective Presence WHI	Presence Detectors	52-53
072815 C	iMS Multi-3 360° 0-10V Dim Presence WHI	Presence Detectors	56-57
072822	iMSL Multi Mercury 100W WHI	Projectors with and without sensors	94-95
072839	iMSL Multi Mercury 100W BLK	Projectors with and without sensors	94-95
072846	iMS RC6	Accessory for detectors	56-61
072921	iMS Multi Mounting Box AP/UP IP65 WHI	Accessory for detectors	36-39, 50-51, 54-59, 62-63
072976	iMS 360° Emb Plan BLK	PIR Motion Detectors	12-13
072983	iMS 360°-1 BLK	PIR Motion Detectors	24-25
072990	iMS Multi BLK Housing	Accessory for detectors	36-39, 50-51, 54-59, 62-63
818409 V2	iMS 180° Mini WHI	PIR Motion Detectors	10-11
818423	iMSL 360° Venus E27 PMMA WHI	Lighting with a high-frequency sensor	84-85
818454	iMS M4-3 360° WHI	PIR Motion Detectors	28-29
818461 iC	iMS M4-4 360° Presence WHI	Presence Detectors	48-49
818478	iMS Alpha Twilight WHI	Twilight Photocells	70-71
818485	iMS 360° HF Int WHI	High-Frequency Motion Detectors	42-43

# Motion Detectors



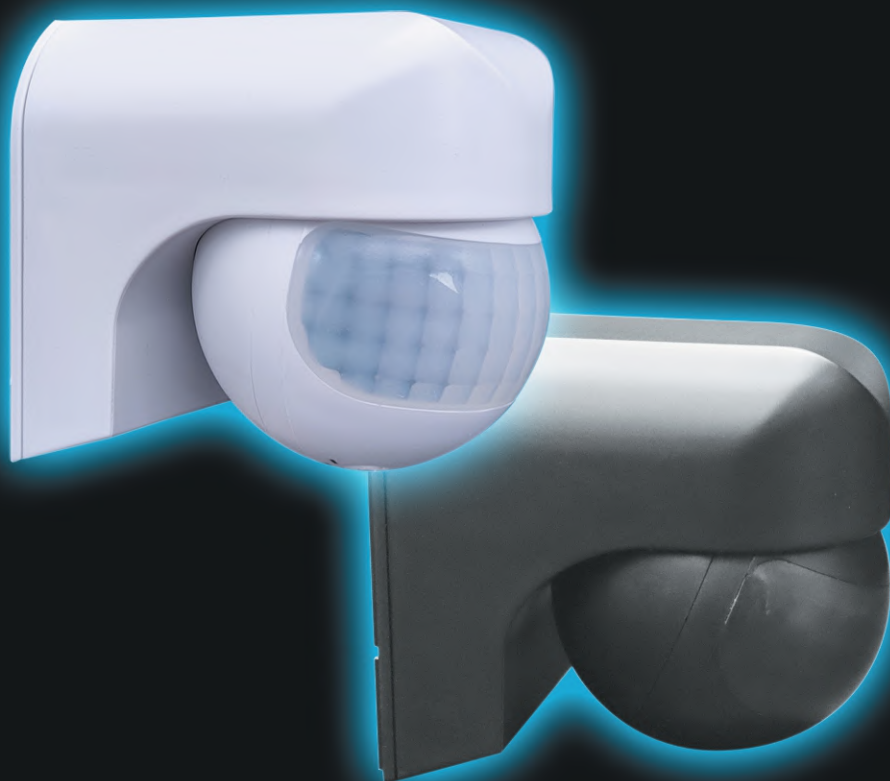

# 01

## PIR Motion Detectors

iMS 180° Mini WHI - 818409 V2  
iMS 180° Mini BLK - 072396 V2  
iMS 360° Emb Plan WHI - 072174 V3  
iMS 360° Emb Plan BLK - 072976  
iMS 360° Mini Emb Plan WHI - 072389  
iMS Multi 360° Micro Emb WHI - 072525  
iMS 180° Emb WHI - 072419  
iMS 200° AP/UP IP65 WHI - 072655 C  
iMS 360° Micro WHI - 072143  
iMS 360° -1 WHI - 072624

iMS 360° -1 BLK - 072983  
iMS Multi 360° WHI - 072433  
iMS M4-3 360° WHI - 818454  
iMS M4-Corridor WHI - 072334 iC  
iMS M4-2 200°/360° WHI - 072631 C  
iMS Multi 270/360 WHI - 072426 V2 C  
iMS Multi 270/360 BLK - 072457 V2 C  
iMS Multi Corridor WHI - 072648  
iMS Multi-3 360° WHI - 072471 V2 C

Universal Range  
★★★★★



## IMS 180° Mini WHI / BLK

Surface-mounted motion detector with an infrared sensor, suitable for installation on walls, ceilings, corners or around edges.

With its sleek, simple design, the mini infrared motion detector blends discreetly into any setting.

It is an ergonomic and versatile detector, suitable for installation on ceilings, walls, corners and edges, and comes with the appropriate mounting bracket included.

It provides a wide detection field, as the lens can be adjusted in any direction along its axis. It has a range of 12 metres.

The detection coverage can be restricted using the included masks.

This detector has a high switching capacity, enabling it to handle high loads. It allows for continuous time adjustment and twilight control. Its protection rating (IP65) allows for indoor and outdoor use, and it can be exposed to the elements.

It is the ideal product for detecting movement in open and wide-open areas and can be installed at various heights to monitor body movements.

This detector is manufactured to high-quality and performance standards, designed to achieve maximum energy efficiency whilst respecting the environment throughout its manufacturing process.

The detector is made from UV-resistant plastic, ensuring greater durability.



PIR



2000W



1000W



180°



12m



3-2000lux



10s-15min

IP  
65

## Technical Summary

White Product Code	iMS 180° Mini WHI – 818409 V2
Black Product Code	iMS 180° Mini BLK – 072396 V2
Sensor Type	Infrared
Lens Type	Multi-lens – emits a greater number of beams per square metre
Power	2000W (incandescent and fluorescent bulbs), 1000W (energy-saving and LED bulbs)
Voltage	220V/AC-240V/AC / 50HZ
Detection Angle	180°
Detection Range	Max. 12m
Type of Protection	IP65
Twilight Regulation	3 – 2000Lux (Adjustable)
Time Adjustment	10seg a 15min
Ideal Installation Height	2 - 3m ceiling   1.8 - 5m wall
Application	Walls, ceilings, corners and edges
Measures	Ø78mm x 71mm
Certification	CE
Masks	Includes self-adhesive masks

### Detection Area

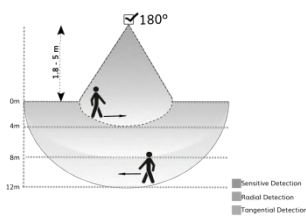

### Wiring Diagram

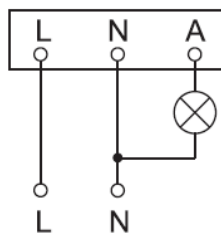

### Technical Drawing

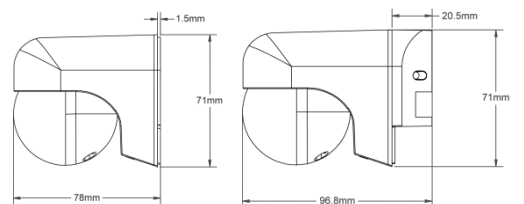

### Detection Diagram

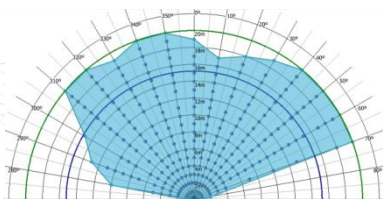

### Technical Summary



White



Black

### Product Code



White



Black



Universal Range  
★★★★★



## iMS 360° Emb Plan WHI / BLK

Motion detector with infrared sensor for flush-mounted installation in the ceiling.

The new, more discreet and slimmer flush-mounted infrared motion detector, which is virtually invisible on the ceiling.

It can be fitted into deep recesses. It is the ideal size for covering the holes left by the installation of spotlights or downlights.

This detector has a range of 12 metres.

The detector offers quick access to programming by simply pulling out the drawer that is visible once installed.

This detector has a high switching capacity, enabling it to handle high loads. It allows for continuous adjustment of the time and twilight setting.

It is ideal for installation on the ceiling at a considerable height. It is the ideal product for use in monitoring offices, storage rooms, entrance halls, balconies and toilets, as its high protection rating (IP65) protects it against the elements.

This detector is manufactured to high-quality and performance standards, in order to achieve maximum energy efficiency, whilst respecting the environment throughout the manufacturing process.

The detector is made from UV-resistant plastic, ensuring greater durability.

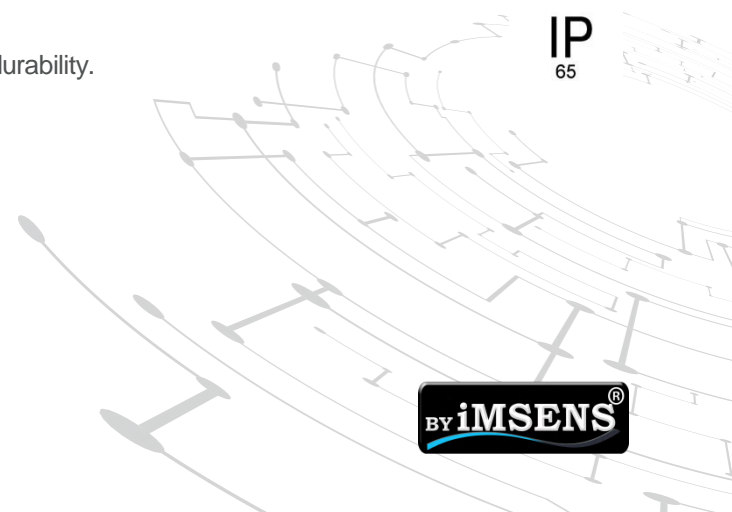

## Technical Summary

White Product Code	iMS 360° Emb Plan WHI - 072174 V3
Black Product Code	iMS 360° Emb Plan BLK - 072976
Sensor Type	Infrared
Lens Type	Multi-lens – emits a greater number of beams per square metre
Power	2000W (incandescent and fluorescent bulbs), 1000W (energy-saving and LED bulbs)
Voltage	220V/AC-240V/AC / 50HZ
Detection Angle	360°
Detection Range	Max. 12m
Type of Protection	IP65
Twilight Regulation	10 – 2000Lux (Adjustable)
Time Adjustment	10seg a 15min
Ideal Installation Height	2.2 – 4m
Application	Ceiling
Measures	Ø61mm x 53.4mm
Certification	CE

Detection Area

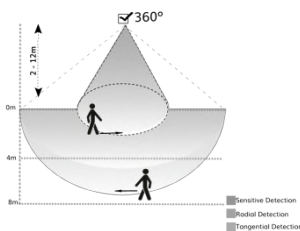

Wiring Diagram

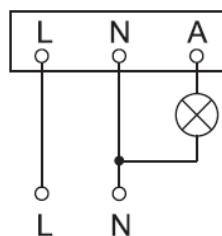

Technical Drawing

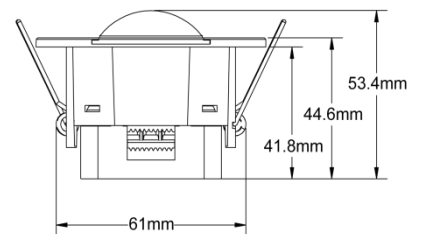

Detection Diagram

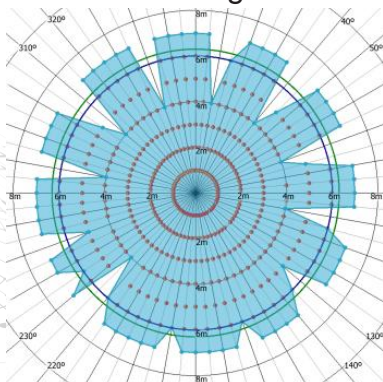

Technical Summary



White



Black

Product Code



White



Black



Universal Range  
★★★★★



## iMS 360° Mini Emb Plan WHI

Motion detector with infrared sensor for flush-mounted installation in the ceiling.

The smallest and most discreet flush-mounted motion detector with an ultra-slim design. Features an infrared sensor and a 360° detection field with a range of 6 metres. Ideal for flush mounting in the ceiling so that it is almost imperceptible, with only the sensor lens remaining visible.

Installation is practical and simple; simply remove the lens to make programming adjustments in a simplified manner.

Ideal for use in bathrooms, changing rooms, small storage areas, stairwells and small entrance halls.

It allows for continuous adjustment of the timing and light output. It is ideal for installation on the ceiling at a considerable height.

As it is made from UV-resistant plastic, it offers greater durability.

The lighting switches on and off as required, resulting in significant energy cost savings.

This detector is manufactured to high standards of quality and performance, in order to achieve maximum energy efficiency, whilst respecting the environment throughout the manufacturing process.



## Technical Summary

Product Code	iMS 360° Mini Emb Plan WHI - 072389
Sensor Type	Infrared
Lens Type	Multi-lens – emits a greater number of beams per square metre
Power	800W (incandescent and fluorescent bulbs), 400W (energy-saving and LED bulbs)
Voltage	220V/AC-240V/AC / 50HZ
Detection Angle	360°
Detection Range	Max. 6m
Type of Protection	IP20
Twilight Regulation	10 – 2000Lux (Adjustable)
Time Adjustment	10seg a 7min
Ideal Installation Height	2.2 – 3m
Application	Ceiling
Measures	Ø49.8mm x 61mm
Certification	CE

Detection Area

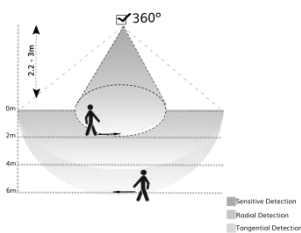

Wiring Diagram

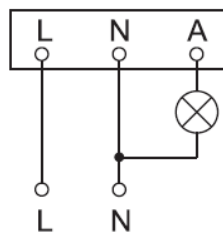

Technical Drawing

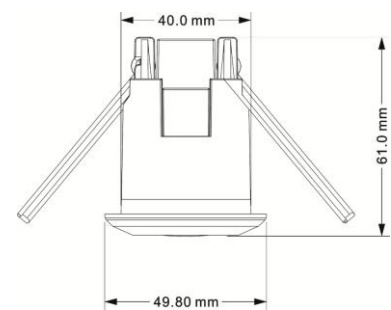

Detection Diagram

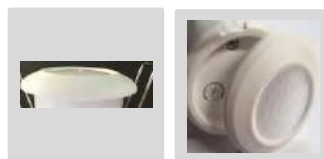
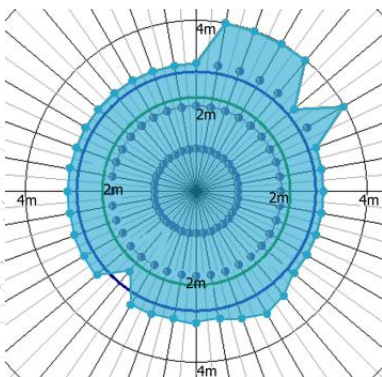

Technical Summary



Product Code



Multi-PRO Range  
★★★★★

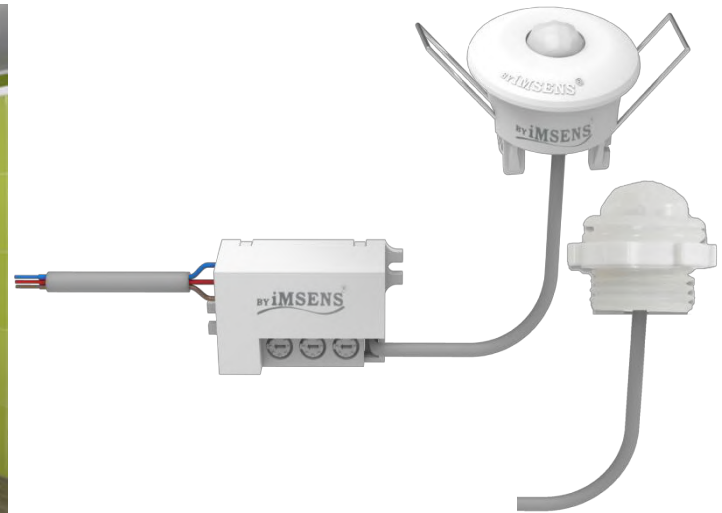

## iMS Multi 360° Micro Emb WHI

Motion detector with infrared sensor for flush-mounted installation on ceilings and walls.

This is a mini flush-mounted motion detector with an infrared sensor, designed for a wide range of applications, as it offers two installation options: flush-mounted in the ceiling using the springs, or screwed directly into place using the rings, making it the ideal solution for a variety of applications. It is a very discreet detector with a high degree of protection (IP20/65), as its lens is sealed, making it an excellent choice for both outdoor and indoor applications. It is a detector with a 360° detection angle and a range of up to 6 metres.

It is the ideal product for monitoring small areas such as: changing rooms, toilet cubicles, small entrance halls, amongst others. Its versatility makes it the ideal solution for recessing into cupboards, wardrobes, etc., wherever reliable yet discreet detection is required.

This detector is manufactured to high-quality and performance standards, ensuring maximum energy efficiency whilst respecting the environment throughout the manufacturing process.

The detector is made from UV-resistant plastic, ensuring greater durability.



## Technical Summary

Product Code	iMS Multi 360° Micro Emb WHI - 072525
Sensor Type	Infrared
Lens Type	Multi-lens – emits a greater number of beams per square metre
Power	100W (incandescent and fluorescent bulbs), 100W (energy-saving and LED bulbs)
Voltage	220V/AC-240V/AC / 50HZ
Detection Angle	360°
Detection Range	Max. 6m
Type of Protection	IP20/IP65
Twilight Regulation	10 - 2000Lux (Adjustable)
Time Adjustment	10seg a 7min
Ideal Installation Height	1.8 – 2.8m ceiling   1.5 – 1.8m wall
Application	Ceiling and Wall
Measures	Ø39.8mm x 40.2mm   Ø26.8mm x 23.8mm
Certification	CE

### Detection Area

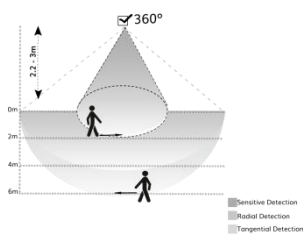

### Detection Diagram

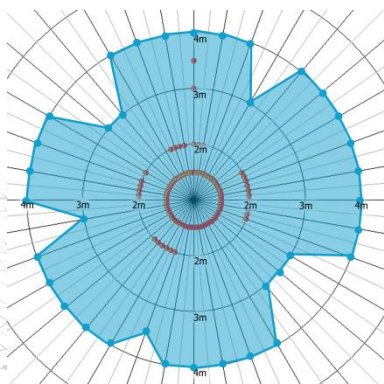

### Wiring Diagram

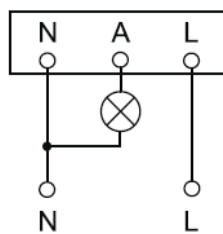

### Technical Drawing

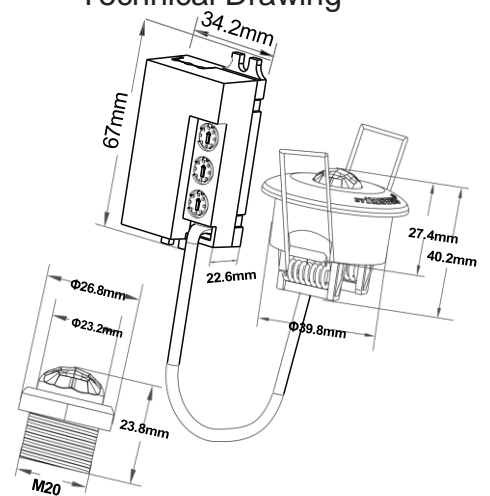

### Technical Summary



Product Code



5 600244 072525



Universal Range  
★★★★★



## iMS 180° Emb WHI

Motion detector with infrared sensor for flush-mounted installation.

Flush-mounted indoor motion detector with an infrared sensor, designed for easy integration of automatic lighting in both new and existing buildings. This detector is easy to install and is ideal for replacing existing flush-mounted switches in universal junction boxes—whether wired with 2 or 3 wires—with sensor-equipped switches.

It can be retrofitted into existing lighting systems with conventional installation boxes, as well as during the initial installation of houses, flats and commercial premises.

It has a range of 10 metres with a detection angle of 180°.

It also features an integrated selector button offering 3 functions: ON / OFF / PIR – AUTO sensor.

It allows for continuous time adjustment and twilight control.

It is suitable for wall mounting, ideal for use in entrance halls, lift lobbies or stairwells.

Made from UV-resistant plastic for greater durability.

This detector is manufactured to high-quality and performance standards to achieve maximum energy efficiency, whilst respecting the environment throughout the manufacturing process.



## Technical Summary

Product Code	iMS 180° Emb WHI - 072419
Sensor Type	Infrared
Lens Type	Multi-lens – emits a greater number of beams per square metre
Power	500W (incandescent and fluorescent bulbs), 200W (energy-saving and LED bulbs)
Voltage	220V/AC-240V/AC / 50HZ
Detection Angle	180°
Detection Range	Max. 10m
Type of Protection	IP20
Twilight Regulation	10 - 2000Lux (Adjustable)
Time Adjustment	10seg a 7min
Ideal Installation Height	0.8 - 1.8m
Application	Wall
Measures	80mm x 50.10mm
Certification	CE

Detection Area

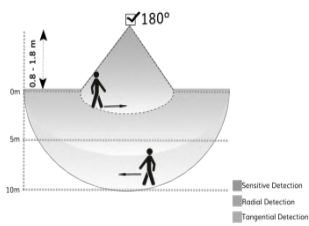

Detection Diagram

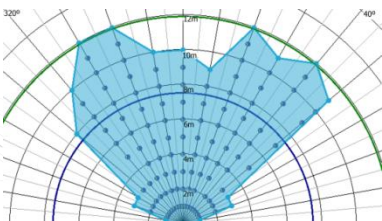

Wiring Diagram

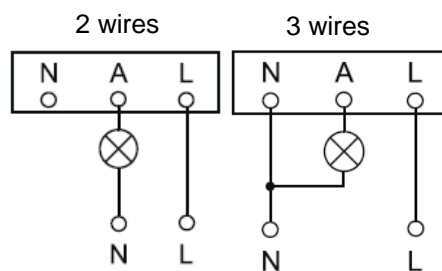

Technical Drawing

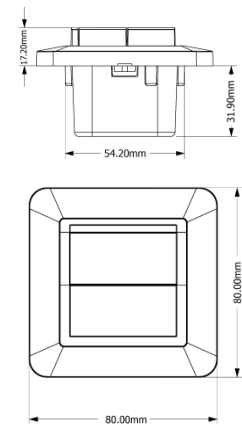

Technical Summary



Product Code





Multi-PRO Range  
★★★★★



## iMS 200° AP/UP IP65 WHI

Motion detector with infrared sensor for surface-mounted or flush-mounted installation.

200° multi-purpose motion detector for surface-mounted or flush-mounted installation, featuring an infrared sensor, for easy integration of automatic lighting in new and existing buildings, with a high degree of weatherproofing for both outdoor and indoor use. It provides security, comfort and energy savings through automatic light switching. It can be installed in existing lighting systems with conventional, flush-mounted or surface-mounted installation boxes. It allows for the simple replacement of conventional switches with sensor switches.

This detector has a high switching capacity, thus supporting high loads. It allows for continuous adjustment of the time and twilight control. It can be fitted into an existing weatherproof box or a recessed box that has already been installed, whilst maintaining its high level of weatherproofing. It is the ideal product for monitoring corridors, stairwells, bathrooms, kitchens, basements, machine rooms, garages, façades, building entrances, and more, as its high protection rating (IP65) protects it against the elements.

This detector can be programmed using the potentiometers or via the RC3 remote control. (Sold separately).

This detector is manufactured to high-quality and performance standards, with the aim of achieving maximum energy efficiency whilst respecting the environment throughout the manufacturing process.

The detector is made from UV-resistant plastic, ensuring greater durability.



## Technical Summary

Product Code	iMS 200° AP/UP IP65 WHI - 072655 C
Sensor Type	Infrared
Lens Type	Multi-lens – emits a greater number of beams per square metre
Power	2000W (incandescent and fluorescent bulbs), 1000W (energy-saving and LED bulbs)
Voltage	220V/AC-240V/AC / 50HZ
Detection Angle	200°
Detection Range	Max. 10m
Type of Protection	IP65
Twilight Regulation	10 - 2000Lux (Adjustable)
Time Adjustment	10seg a 30min
Ideal Installation Height	0.8 - 3m
Application	Wall
Measures	87mm x 78.3mm
Pipe-passing hole diameter	18,5mm
Certification	CE
Command	Remote Control RC3 - 072709 (Sold separately)

### Detection Area

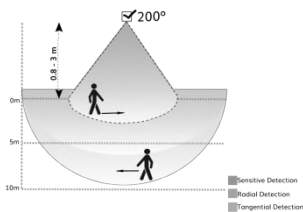

### Wiring Diagram

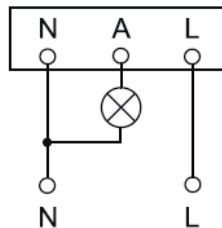

### Technical Drawing

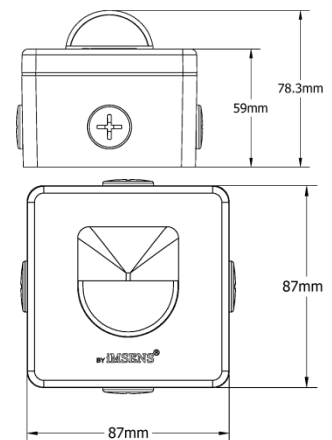

### Detection Diagram

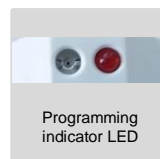
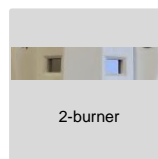
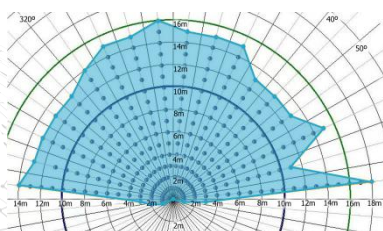

### Technical Summary



Product Code



5 600244 072655



Universal Range  
★★★★★



## iMS 360° Micro WHI

Motion detector with infrared sensor for surface-mounted installation on the ceiling or wall.

The micro motion detector with a protruding infrared sensor is ideal for any application in universal mounting boxes, as well as for covering the holes left by spotlights and downlights, as its mounting holes align exactly with those of the flush-mounted boxes, thus making installation easier.

A small, discreet detector, yet featuring multi-lenses for precise detection, designed for areas where movement is infrequent, as it has a highly effective lens.

With a built-in 360° infrared sensor, offering a detection range of up to 3 metres. It allows for continuous adjustment of the time and twilight setting.

Ideal for bathrooms, changing rooms, small storage areas, small rooms, entrance halls, and more.

This detector is manufactured to high-quality and performance standards to achieve maximum energy efficiency, whilst respecting the environment throughout the manufacturing process.

Made from UV-resistant plastic for greater durability.



## Technical Summary

Product Code	iMS 360° Micro WHI - 072143
Sensor Type	Infrared
Lens Type	Multi-lens – emits a greater number of beams per square metre
Power	100W (incandescent and fluorescent bulbs), 100W (energy-saving and LED bulbs)
Voltage	220V/AC-240V/AC / 50HZ
Detection Angle	360°
Detection Range	Max. 3m
Type of Protection	IP20
Twilight Regulation	10 - 2000Lux (Adjustable)
Time Adjustment	10seg a 7min
Ideal Installation Height	2 – 2.8m ceiling   1 – 1.5m wall
Application	Ceiling and wall
Measures	Ø75mm x 27.6mm
Certification	CE

Detection Area

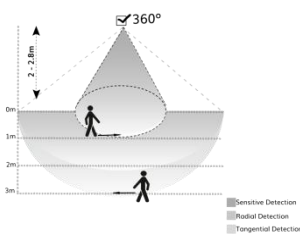

Wiring Diagram

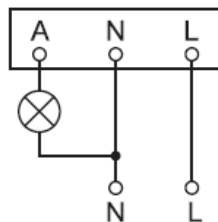

Technical Drawing

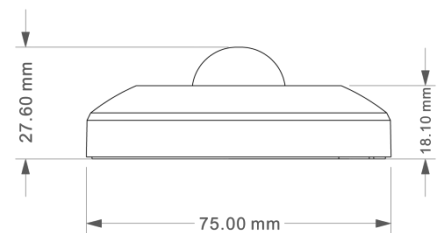

Detection Diagram

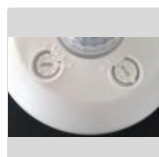
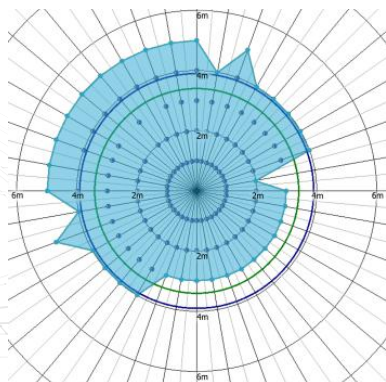

Technical Summary



Product Code





Universal Range  
★★★★★



## iMS 360°-1 WHI / BLK

Motion detector with infrared sensor for surface-mounted installation on the ceiling.

The surface-mounted ceiling infrared detector that meets all requirements and is really easy to install.

Designed to meet the significant demand for detection in rooms with both low and high ceilings.

Discreet and ergonomic, it is easy to install and can be used in a wide range of applications: garages, corridors, living rooms, and large entrance halls of various heights, amongst others. With its lens featuring advanced dioptric correction, it ensures, even at varying heights, perfect detection performance.

It allows for continuous adjustment of the time and twilight setting. It is designed for surface-mounted installation on the ceiling, making it ideal for both indoor and outdoor use thanks to its IP54 rating, which protects it from the elements.

This detector is manufactured to high-quality and performance standards, designed to achieve maximum energy efficiency whilst respecting the environment throughout its manufacturing process.

The detector is made from UV-resistant plastic, ensuring greater durability.



## Technical Summary

White Product Code	iMS 360°-1 WHI - 072624
Black Product Code	iMS 360°-1 BLK - 072983
Sensor Type	Infrared
Lens Type	Multi-lens – emits a greater number of beams per square metre
Power	1200W (incandescent and fluorescent bulbs), 300W (energy-saving and LED bulbs)
Voltage	220V/AC-240V/AC / 50HZ
Detection Angle	360°
Detection Range	Max. 14m
Type of Protection	IP54
Twilight Regulation	10 - 2000Lux (Adjustable)
Time Adjustment	10seg a 7min
Ideal Installation Height	2.2 - 4m
Application	Ceiling
Measures	Ø88mm x 49.5mm
Certification	CE

Detection Area

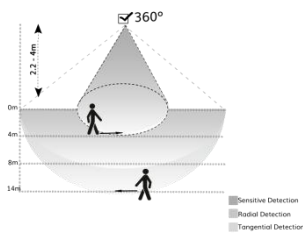

Wiring Diagram

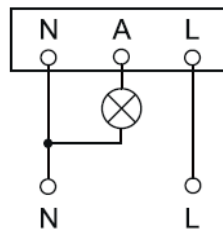

Technical Drawing

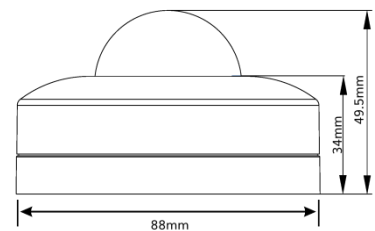

Detection Diagram

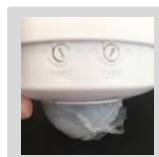
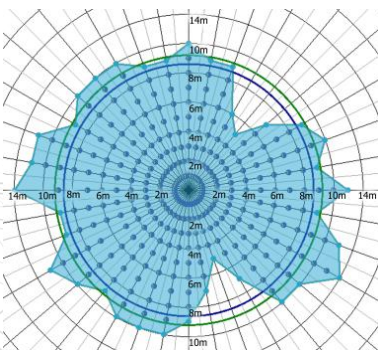

Technical Summary



White



Black

Product Code



White



Black



Multi-PRO Range  
★★★★★



## iMS Multi 360° WHI

Motion detector with infrared sensor for flush-mounted or surface-mounted installation on the ceiling.

This is a motion detector with an infrared sensor, suitable for a wide range of applications, as it can be mounted either flush with the ceiling or surface-mounted. It has a 360° detection angle and a range of 8 metres. This detector has a high switching capacity, enabling it to handle heavy loads.

It is the ideal product for monitoring areas with low levels of movement, such as offices, reception areas, entrance halls, offices, bathrooms, and more.

It is designed with an ergonomic shape that makes programming easy even after installation, as the programming dials are accessible on the detector itself: simply twist off the cover to reveal the programming dials. Its flat lens gives the product a more welcoming and appealing design.

This sensor is manufactured to exacting standards of high quality and performance, in order to achieve maximum energy efficiency, whilst respecting the environment throughout its manufacturing process.

Made from UV-resistant plastic for greater durability.



## Technical Summary

Product Code	iMS Multi 360° WHI - 072433
Sensor Type	Infrared
Lens Type	Multi-lens – emits a greater number of beams per square metre
Power	2000W (incandescent and fluorescent bulbs), 1000W (energy-saving and LED bulbs)
Voltage	220V/AC-240V/AC / 50HZ
Detection Angle	360°
Detection Range	Max. 8m
Type of Protection	IP20/IP54
Twilight Regulation	10 - 2000Lux (Adjustable)
Time Adjustment	10seg a 7min
Ideal Installation Height	2.2 - 3m
Application	Ceiling
Measures	Ø73mm x 27.9mm
Certification	CE

Detection Area

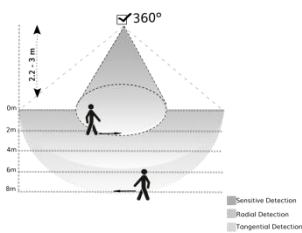

Wiring Diagram

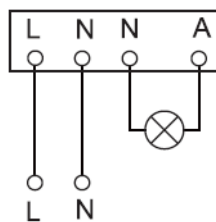

Technical Drawing

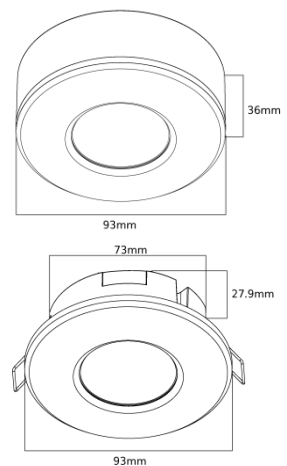

Detection Diagram

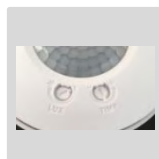
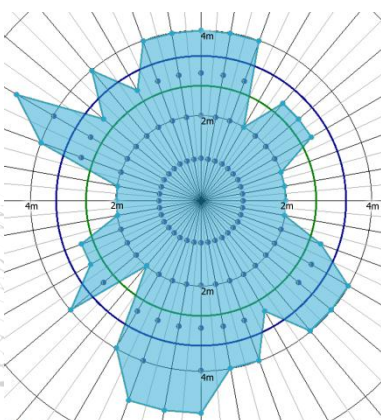

Technical Summary



Product Code



5 600244 072433 >



Multi-PRO Range  
★★★★★



## iMS M4-3 360° WHI

Surface-mounted motion detector with infrared sensor for ceiling and wall installation.

This is an ergonomic and versatile surface-mounted infrared detector for ceiling and wall installation. The standard power supply unit can be easily pre-installed thanks to the generous connection space. Wiring is simple and straightforward. The supplied masks are used to limit the detection area.

By removing the snap-on cover, the range can be adjusted quickly and precisely.

This detector has a high switching capacity, enabling it to handle high loads. It allows for continuous adjustment of the time and twilight control.

It can be installed on ceilings or walls, making it ideal for carports, porches, garages and car parks, warehouses, halls and lobbies, as its high protection rating (IP54) protects it from the elements.

This sensor is manufactured to high-quality and performance standards, designed to achieve maximum energy efficiency whilst respecting the environment throughout its manufacturing process.

The sensor is made from UV-resistant plastic, ensuring greater durability.



IP  
54



## Technical Summary

Product Code	iMS M4-3 360° WHI – 818454
Sensor Type	Infrared
Lens Type	Multi-lens – emits a greater number of beams per square metre
Power	2000W (incandescent and fluorescent bulbs), 1000W (energy-saving and LED bulbs)
Voltage	220V/AC-240V/AC / 50HZ
Detection Angle	360°
Detection Range	Max. 20m
Type of Protection	IP54
Twilight Regulation	10 - 2000Lux (Adjustable)
Time Adjustment	10seg a 10min
Ideal Installation Height	2 – 8m Ceiling   1.8 – 2.2m Wall
Application	Ceiling and wall
Measures	58.3mm x 102.5mm
Certification	CE
Masks	Includes self-adhesive masks

Detection Area

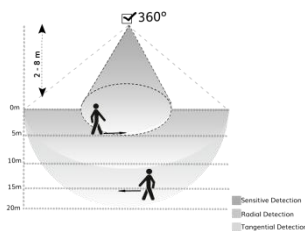

Detection Diagram

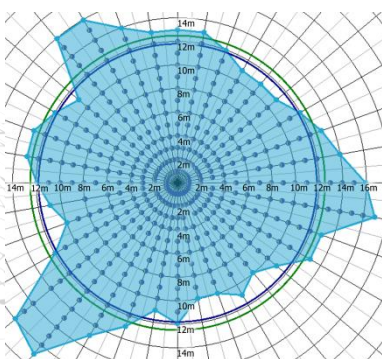

Wiring Diagram

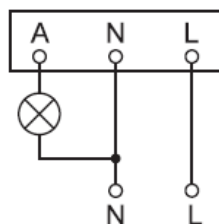

Technical Drawing

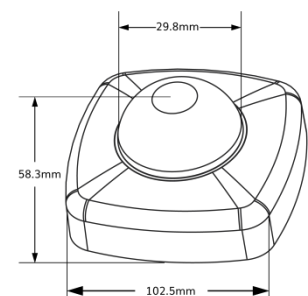

Technical Summary



Product Code



5 600630 818454 >



Stick-on masks



Multi-PRO Range  
★★★★★



## iMS M4-Corridor WHI

Surface-mounted motion detector with infrared sensor for use in corridors.

This is an ergonomic and versatile detector with a protruding infrared sensor, designed for ceiling and wall mounting, and ideal for use in hallways and high-traffic areas.

It allows for easy pre-installation of the standard power supply, thanks to the large connection space, and wiring is also simple and convenient.

The RC3 remote control is included with the detector and is used for all programming. This detector has a high switching capacity, thus supporting high loads.

It allows for continuous adjustment of the time and twilight setting. The detector offers lighting control that adapts to the needs of functional spaces. This means that greater energy efficiency is combined with greater comfort.

It allows for ceiling and wall installation in locations such as: pavilions, general warehouses, shelters, and hallways. Its high protection rating (IP55) protects it from the elements. It can also be installed in locations with high ceilings.

This detector is manufactured to exacting high-quality and performance standards to achieve maximum energy efficiency, with an environmentally conscious manufacturing process.

It is made of UV-resistant plastic, ensuring greater durability.



## Technical Summary

Product Code	iMS M4-Corridor WHI – 072334 iC
Sensor Type	Infrared
Lens Type	Multi-lens – emits a greater number of beams per square metre
Power	2000W (incandescent and fluorescent bulbs), 1000W (energy-saving and LED bulbs)
Voltage	220V/AC-240V/AC / 50HZ
Detection Angle	360°
Detection Range	Max. 4m width, max. 20m length
Type of Protection	IP55
Twilight Regulation	10 - 2000Lux (Adjustable)
Time Adjustment	10seg a 30min
Ideal Installation Height	2 – 12m Ceiling   1.8 – 3m Wall
Application	Ceiling and wall
Measures	58.3mm x 102.5mm
Certification	CE
Masks	Includes self-adhesive masks
Command	Includes command RC3 - 072709

Detection Area

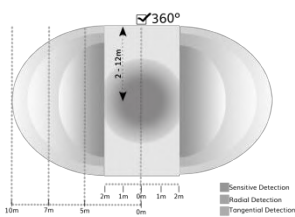

Wiring Diagram

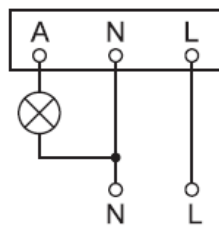

Technical Drawing

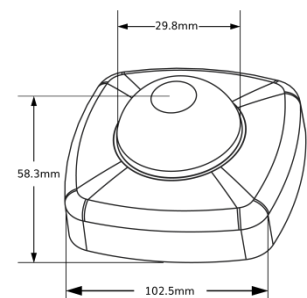

Detection Diagram

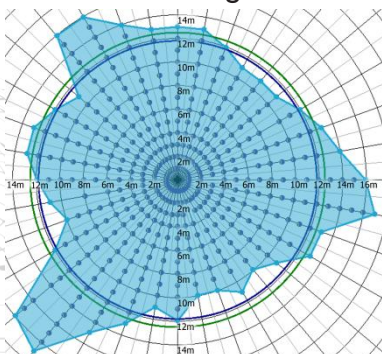

Technical Summary



Product Code





## iMS M4-2 200°/360° WHI

Motion detector with infrared sensor for surface-mounted installation on walls, corners and edges.

Motion detector with infrared sensor for surface-mounted installation, offering a detection range of 200° and 360°, providing a wide detection area.

It can be installed on walls, in corners and on edges, with the appropriate bracket included. It can be used both indoors and outdoors thanks to its high protection rating (IP55). Simple installation thanks to the connection base.

This detector has a high switching capacity, thus supporting high loads. It allows for continuous adjustment of the time and twilight setting.

It can be installed on walls, in corners and on edges, making it ideal for monitoring outdoor areas, entrances, access routes, car parks, underground car parks, warehouses with high-bay racking, and more.

The programming of this detector can be adjusted using the potentiometers or via the RC3 remote control (sold separately).

It is a detector manufactured to high-quality and performance standards, designed to achieve maximum energy efficiency whilst respecting the environment throughout its manufacturing process.

The detector is made from UV-resistant plastic, ensuring greater durability.



## Technical Summary

Product Code	iMS M4-2 200°/360° WHI – 072631 C
Sensor Type	Infrared
Lens Type	Multi-lens – emits a greater number of beams per square metre
Power	2000W (incandescent and fluorescent bulbs), 1000W (energy-saving and LED bulbs)
Voltage	220V/AC-240V/AC / 50HZ
Detection Angle	200°/360°
Detection Range	Max. 24m
Type of Protection	IP55
Twilight Regulation	10 - 2000Lux (Adjustable)
Time Adjustment	10seg a 30min
Ideal Installation Height	1.8m – 10m
Application	Walls and corners
Measures	75.5mm x 118.8mm
Certification	CE
Command	Remote Control RC3 - 072709 (Sold separately)

### Detection Area

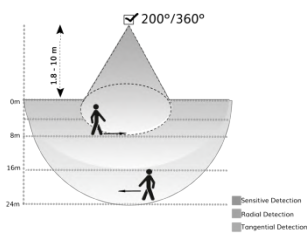

### Wiring Diagram

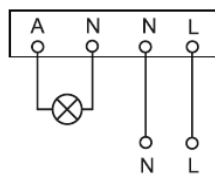

### Technical Drawing

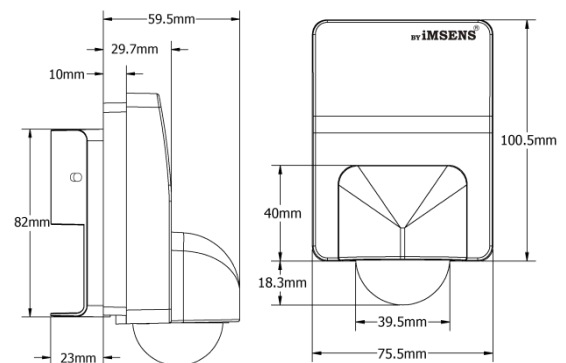

### Detection Diagram

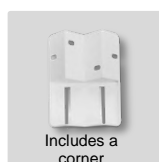
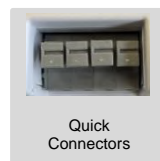
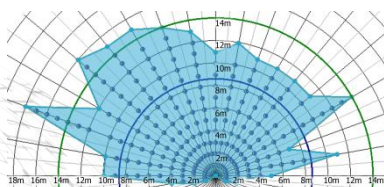

### Technical Summary



### Product Code





Multi-PRO Range  
★★★★★



## IMS Multi 270/360 WHI / BLK

Motion detector with infrared sensor for surface-mounted installation on walls, ceilings and corners.

Motion detector with a protruding infrared sensor, offering a detection range of 270° and 360°, providing a wide detection area thanks to its lens, which can be adjusted in any direction along its axis.

It can be mounted on walls, ceilings and in corners, and comes with the appropriate mounting bracket included. It can be used both indoors and outdoors thanks to its protection rating (IP55). Simple installation thanks to the connection base.

This detector has a high switching capacity, thus supporting high loads. It allows for continuous adjustment of the time and twilight setting.

It is the ideal product for monitoring outdoor areas, entrances, access routes, car parks, underground car parks, warehouses with high-bay racking, amongst others.

On this detector, the settings can be adjusted using the potentiometers or via the RC3 remote control (sold separately).

This detector is manufactured to high-quality and performance standards, with the aim of achieving maximum energy efficiency whilst respecting the environment throughout the manufacturing process.

The detector is made from UV-resistant plastic, ensuring greater durability.



## Technical Summary

White Product Code	iMS Multi 270/360 WHI – 072426 V2 C
Black Product Code	iMS Multi 270/360 BLK – 072457 V2 C
Sensor Type	Infrared
Lens Type	Multi-lens – emits a greater number of beams per square metre
Power	2000W (incandescent and fluorescent bulbs), 1000W (energy-saving and LED bulbs)
Voltage	220V/AC-240V/AC / 50HZ
Detection Angle	270°/360°
Detection Range	Max. 12m
Type of Protection	IP55
Twilight Regulation	3 - 2000Lux (Adjustable)
Time Adjustment	10seg a 15min
Ideal Installation Height	2.2 – 3.5m ceiling   1.8 – 6m wall
Application	Walls, ceilings and corners
Measures	114mm x 78.5mm
Certification	CE
Command	Remote Control RC3 - 072709 (Sold separately)

Detection Area

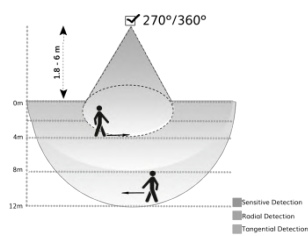

Detection Diagram

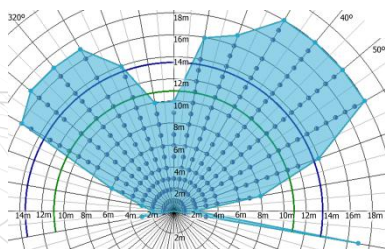

Wiring Diagram

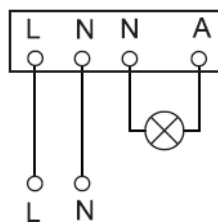

Technical Drawing

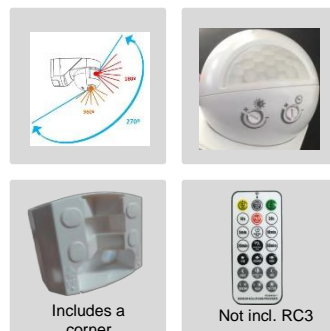
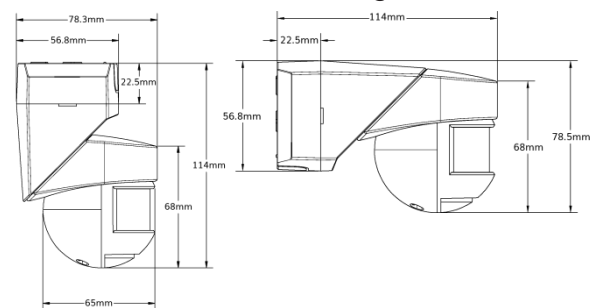

Technical Summary



White



Black

Product Code



White



Black



Multi-PRO Range  
★★★★★



## iMS Multi Corridor WHI

Motion detector with infrared sensor for use in corridors.

This is a motion detector designed for surface-mounted or flush-mounted installation in corridors and passageways.

It is ergonomic and versatile, suitable for a wide range of applications as it can be installed either flush-mounted or surface-mounted, thanks to the accessories included: the springs and the surface-mounting box.

By removing the snap-on cover, the detection range can be adjusted quickly and accurately. This detector is rated IP20/IP55 but can be installed with a waterproof IP65 flush-mounted box (072921). You can also change its housing colour from white to black (072990). (Accessories sold separately).

This detector has a high switching capacity, thus supporting high loads.

It is the ideal product for high-traffic areas such as: halls, general warehouses, shelters, corridors, amongst others, as its high protection rating protects it against the elements. It can also be installed in areas with high ceilings.

The detector is manufactured from UV-resistant plastic, thus ensuring greater durability.

This detector model was developed with the aim of making it a versatile product, as it can be fitted flush using its clips (springs) or surface-mounted using the supplied box; furthermore, the detector body itself is pre-drilled to allow direct fixing into a recessed box using screws.



## Technical Summary

Detector Product Code	iMS Multi Corridor WHI - 072648
Accessory Product Code	iMS Multi BLK Housing - 072990
Accessory Product Code	iMS Multi Mounting Box AP/UP IP65 WHI - 072921
Sensor Type	Infrared
Lens Type	Multi-lens – emits a greater number of beams per square metre
Power	2000W (incandescent and fluorescent bulbs), 1000W (energy-saving and LED bulbs)
Voltage	220V/AC-240V/AC / 50HZ
Detection Angle	360°
Detection Range	Max. 4m width, max. 20m length
Type of Protection	IP20/IP55/IP65
Twilight Regulation	10 - 2000Lux (Adjustable)
Time Adjustment	10seg a 10min
Ideal Installation Height	2 – 12m ceiling   1.8 – 3m wall
Application	Ceiling and wall
Measures	Ø105mm x 58.7mm
Certification	CE

### Detection Area

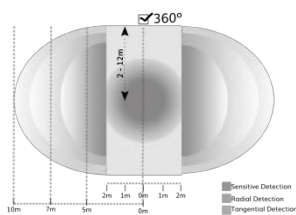

### Detection Diagram

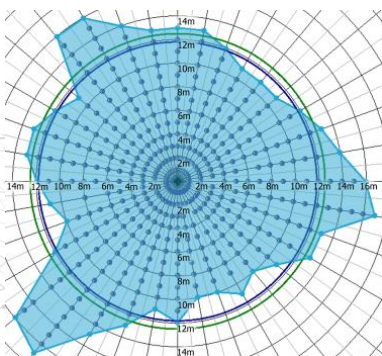

### Wiring Diagram

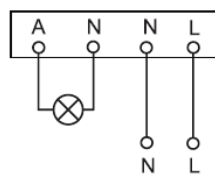

### Technical Drawing

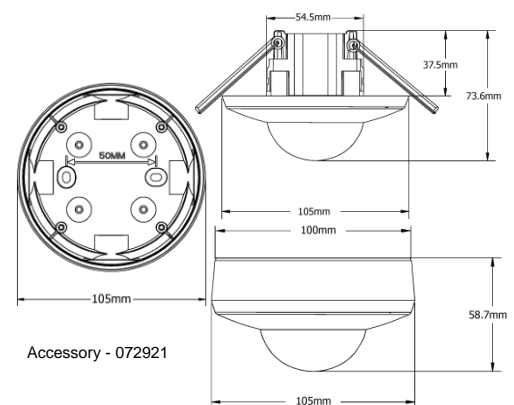

Accessory - 072921

### Technical Summary



Product Code



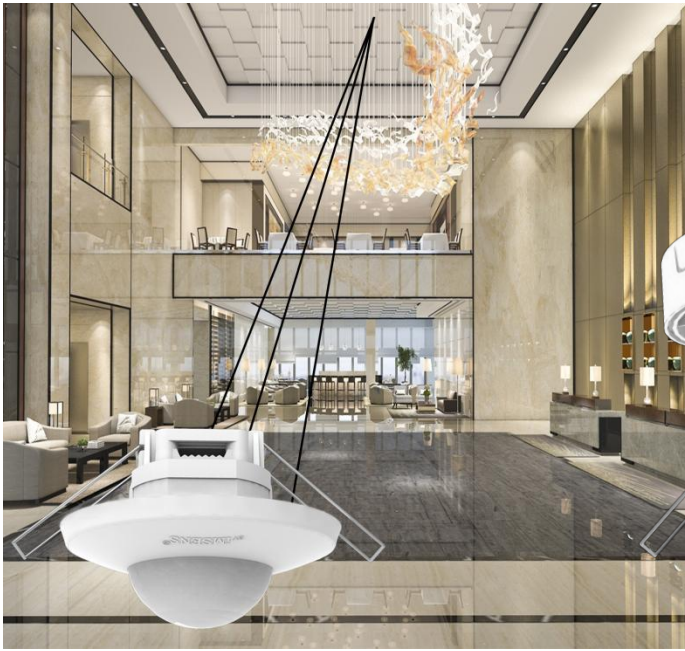

Multi-PRO Range  
★★★★★



## iMS Multi-3 360° WHI

Motion detector with infrared sensor for flush-mounted and surface-mounted installation.

This is a motion detector designed for a wide range of applications, as it can be installed either flush-mounted or surface-mounted, thanks to the accessories included: mounting clips and a surface-mounting box.

This detector model was developed with the aim of making it a versatile product, given that it can be installed flush-mounted using its clips (springs) or surface-mounted using the supplied box; furthermore, the detector body itself is pre-drilled to allow direct fixing to a recessed box using screws.

It is an ergonomic and versatile detector. By removing the snap-on cover, the range can be adjusted quickly and accurately.

This detector is IP20/IP55 rated but can be installed with a waterproof IP65 flush-mounted box (072921). You can also change its housing from white to black (072990). (Accessories sold separately).

This detector can be programmed using the potentiometers or via the RC3 remote control (sold separately). It has a high switching capacity, thus supporting high loads.

It is the ideal product for monitoring large areas such as: garages, car parks, corridors, warehouses, halls, large circulation areas, outdoor balconies, amongst others.

This detector is manufactured to exacting high-quality and performance standards, with the aim of achieving maximum energy efficiency whilst respecting the environment throughout the manufacturing process.

The detector is made from UV-resistant plastic, ensuring greater durability.



PIR



2000W



1000W



360°



20m



10s-1000lux



10s-10min



N/Inc.RC3



IP 20/55/65



## Technical Summary

Detector Product Code	iMS Multi-3 360° WHI – 072471 V2 C
Accessory Product Code	iMS Multi BLK Housing - 072990
Accessory Product Code	iMS Multi Mounting Box AP/UP IP65 WHI - 072921
Sensor Type	Infrared
Lens Type	Multi-lens – emits a greater number of beams per square metre
Power	2000W (incandescent and fluorescent bulbs), 1000W (energy-saving and LED bulbs)
Voltage	220V/AC-240V/AC / 50HZ
Detection Angle	360°
Detection Range	Max. 20m
Type of Protection	IP20/IP55/IP65
Twilight Regulation	10 - 2000Lux (Adjustable)
Time Adjustment	10seg a 10min
Ideal Installation Height	2 – 8m ceiling   1.8 – 2.2m wall
Application	Ceiling and wall
Measures	Ø105mm x 58.7mm
Certification	CE
Command	Remote Control RC3 - 072709 (Sold separately)

Detection Area

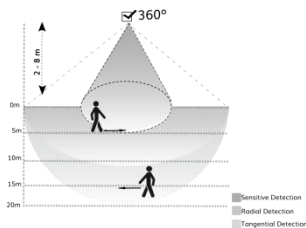

Wiring Diagram

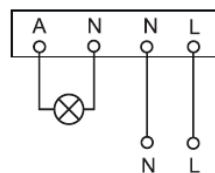

Technical Drawing

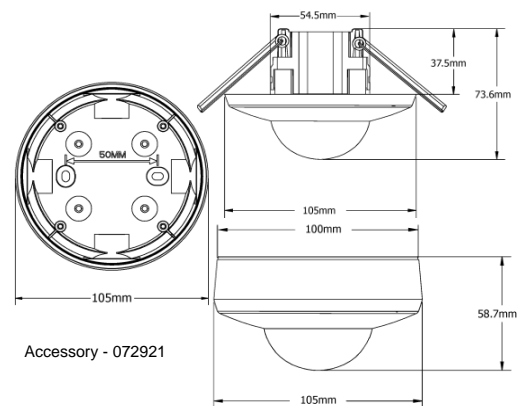

Detection Diagram

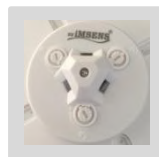
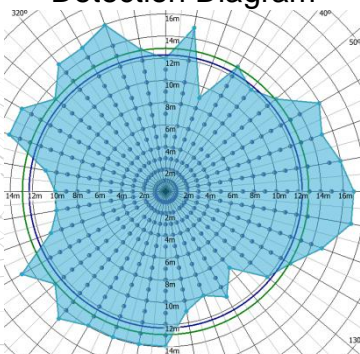

Technical Summary



Product Code



5 600244 072440 >

# Motion Detectors





02.

# High-Frequency Motion Detectors

iMS 360° HF Int WHI- 818485  
iMS M4-HF 360° WHI - 072167



## iMS 360° HF Int WHI

High-frequency motion detector with a wide range of applications.

The high-frequency sensor detects movement instantly by sensing the movement of objects and/or people. The sensor emits short-wave signals and immediately receives the echo reflected from walls and nearby objects. Any movement within the detection area is registered by the sensor in a fraction of a second due to the change in the echo pattern, and the light switches on immediately! After an individually adjustable idle time, the light switches off automatically.

As glass and thin walls do not pose any obstacle to these signals, the sensor can be fitted inside lamps, remaining invisible from the outside and not interfering with the lamp's appearance, as well as being fitted above a false ceiling made of plasterboard and/or wood.

It does not detect through obstacles made of iron, sheet metal, concrete or other materials of high density and thickness. Please note that, due to its detection technology, it detects moving liquids as well as moving air masses (such as concealed pipework within plasterboard walls).

It is a detector with a wide range of ceiling or wall applications, with a 360° detection angle varying depending on the installation location.

It allows for continuous adjustment of the time and twilight settings, as well as sensitivity adjustment via potentiometers. This detector is manufactured to exacting standards of quality and performance, with the aim of achieving maximum energy efficiency whilst ensuring that its manufacturing process is environmentally friendly.

The detector is made from UV-resistant plastic for greater durability.



## Technical Summary

Product Code	iMS 360° HF Int WHI - 818485
Sensor Type	High Frequency
Power	1200W (incandescent and fluorescent bulbs), 300W (energy-saving and LED bulbs)
Voltage	220V/AC-240V/AC / 50HZ
Detection Angle	360°
Detection Range	10m
Type of Protection	IP20
Twilight Regulation	10 - 2000Lux (Adjustable)
Time Adjustment	10seg a 15min
Ideal Installation Height	2m - 5m Ceiling   1.5m - 3m wall
Application	Ceiling and wall
Measures	72mm x 42mm
Certification	CE

Detection Area

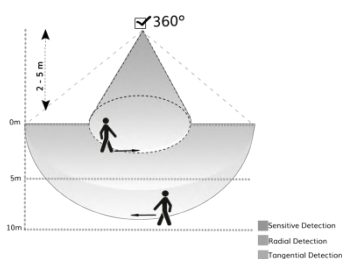

Wiring Diagram

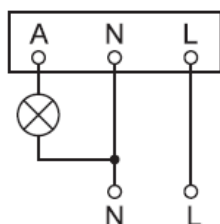

Technical Drawing

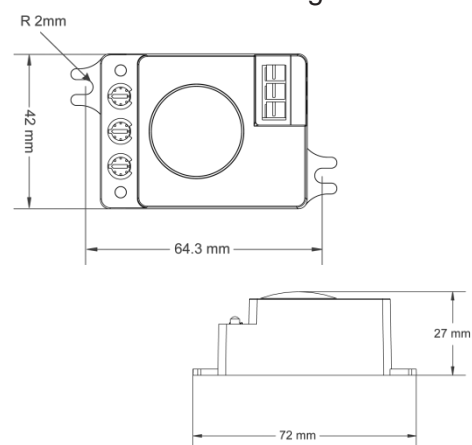

Detection Diagram

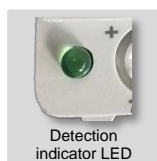
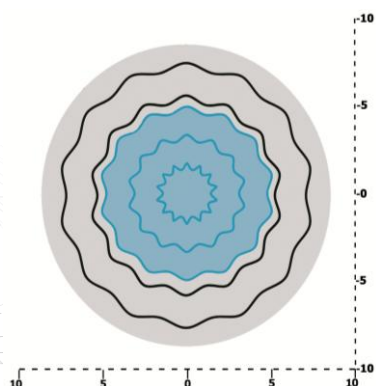

Detection indicator LED

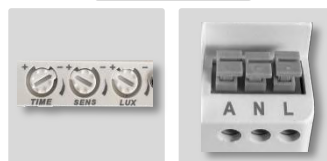

Technical Summary



Product Code





Multi-PRO Range  
★★★★★



## iMS M4-HF 360° WHI

Motion detector with a high-frequency sensor for surface-mounted installation on the ceiling or wall.

The high-frequency sensor detector for surface-mounted installation allows for easy connection thanks to its quick-connect terminals.

The high-frequency sensor detects movement immediately through the movement of objects and/or people. It emits short-wave signals and immediately receives the echo reflected from walls and adjacent objects. Any movement within the detection area is registered in fractions of a second due to the change in the echo pattern, and the light switches on immediately! After an individually adjustable inactivity period, the light switches off automatically. It does not detect through obstacles made of iron, sheet metal, concrete or other materials of high density and thickness. Please note that, due to its detection technology, it detects moving liquids as well as moving air masses (such as concealed pipework within plasterboard walls).

It allows for continuous adjustment of the time and twilight setting, as well as sensitivity adjustment via potentiometers.

It is ideal for ceiling and wall installation, making it the perfect choice for surface-mounted installation in stairwells, bathrooms, garages, storage rooms, entrance halls, corridors, and other areas. Its high protection rating (IP54) protects it from the elements.

This detector is manufactured to exacting high-quality and performance standards, in order to achieve maximum energy efficiency, whilst respecting the environment throughout the manufacturing process.

The detector is made from UV-resistant plastic, ensuring greater durability.



## Technical Summary

Product Code	iMS M4-HF 360° WHI - 072167
Sensor Type	High Frequency
Power	1200W (incandescent and fluorescent bulbs), 300W (energy-saving and LED bulbs)
Voltage	220V/AC-240V/AC / 50HZ
Detection Angle	360°
Detection Range	Max. 10m
Type of Protection	IP54
Twilight Regulation	10 - 2000Lux (Adjustable)
Time Adjustment	10seg a 15min
Ideal Installation Height	2 – 8m Ceiling   1.5 – 3.5m wall
Application	Ceiling and wall
Measures	94.8mm x 94.8mm
Certification	CE

Detection Area

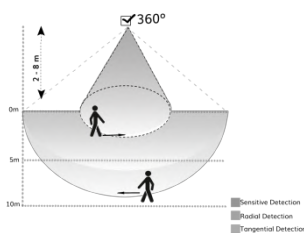

Wiring Diagram

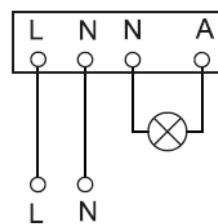

Technical Drawing

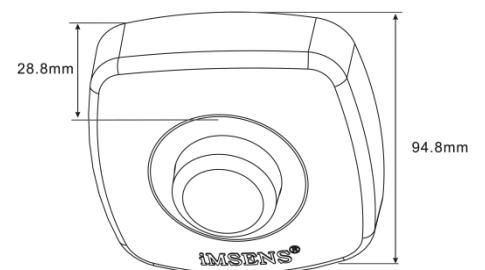

Detection Diagram

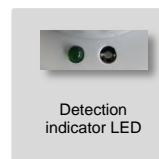
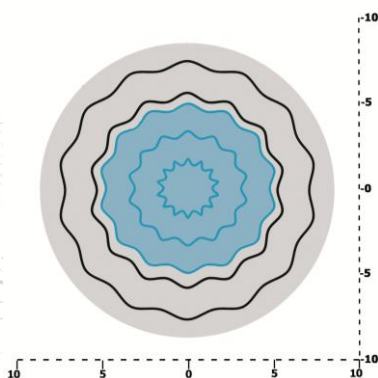

Technical Summary



Product Code



# Presence Detectors





# 03.

## Presence Detectors

- iMS M4-4 360° Presence WHI - 818461 iC
- iMS Multi-4 360° Presence WHI - 072488 iC
- iMS Multi 360° HF Effective Presence WHI - 072808
- iMS Multi-4 360° DualTech Presence WHI - 072495 iC
- iMS Multi-3 360° 0-10v Dim Presence WHI - 072815 C
- iMS Multi-3 360° Dali2 APC Presence WHI - 072501 C
- iMS Multi 360° Dali2 APC Mini Presence WHI - 072662 iC
- iMS Multi-4 360° KNX Presence WHI - 072000



Multi-PRO Range  
★★★★★



## iMS M4-4 360° Presence WHI

Presence detector with infrared sensor for surface-mounted installation on ceilings and walls.

This is a presence detector with a protruding infrared sensor, designed with a square aesthetic but featuring rounded edges, making it easy to install.

The lens has been developed to provide optimal focus, enabling it to detect even the slightest movement and thus deliver the full potential of a presence detector.

It allows for easy installation, thanks to the large connection space, and the wiring is also simple and convenient. The supplied masks are used to limit the detection area.

The RC3 remote control is included with the detector and is used for all programming.

It is an ergonomic and versatile detector, suitable for ceiling and wall mounting. It allows for continuous adjustment of the time and twilight setting.

It is the ideal product for locations where movement is minimal, such as: classrooms, halls, entrance halls, offices, meeting rooms, open-plan offices, amongst others. Its high protection rating (IP55) protects it against the elements.

This detector is manufactured to exacting standards of high quality and performance, in order to achieve maximum energy efficiency, whilst respecting the environment throughout the manufacturing process.

The detector is made from UV-resistant plastic, ensuring greater durability.



## Technical Summary

Product Code	iMS M4-4 360° Presence WHI – 818461 iC
Sensor Type	Infrared
Lens Type	Multi-lens – emits a greater number of beams per square metre
Power	2000W (incandescent and fluorescent bulbs), 1000W (energy-saving and LED bulbs)
Voltage	220V/AC-240V/AC / 50HZ
Detection Angle	360°
Detection Range	Presence max. 6m   Tangential max. 20m
Type of Protection	IP55
Twilight Regulation	5 - 200Lux (Adjustable)
Time Adjustment	10seg a 30min
Ideal Installation Height	2 – 12m Ceiling   1.8 – 3m wall
Application	Ceiling and wall
Measures	58.3mm x 102.5mm
Certification	CE
Masks	Includes self-adhesive masks
Command	Includes command RC3 - 072709

Detection Area

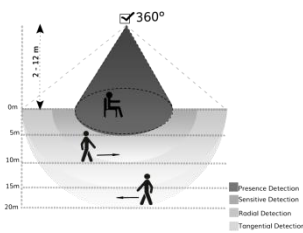

Wiring Diagram

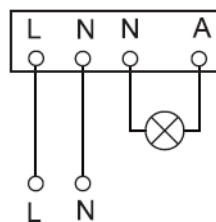

Technical Drawing

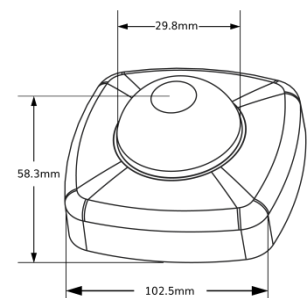

Detection Diagram

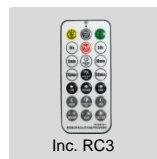
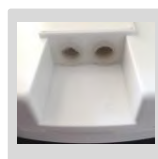
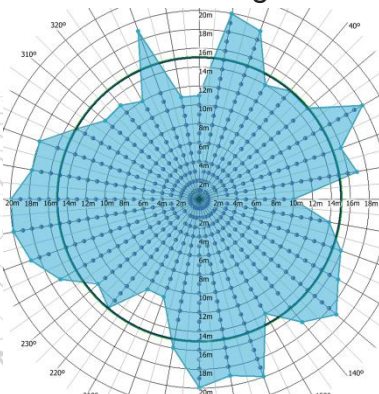

Technical Summary



Product Code



5 600630 818461 >



Multi-PRO Range  
★★★★★



## iMS Multi-4 360° Presence WHI

Presence detector with infrared sensor for flush-mounted or surface-mounted installation on ceilings and walls.

This is a presence detector with an infrared sensor designed for multi-purpose applications, as it can be installed either flush-mounted or surface-mounted, thanks to the accessories included: the springs and the surface-mounting box.

The RC3 remote control is included with the detector and is used to carry out all programming.

It is an ergonomic and versatile detector, suitable for ceiling and wall mounting.

This detector has a high switching capacity, thus supporting high loads.

It is the ideal product for locations with low levels of movement, such as: classrooms, halls, entrance halls, offices, meeting rooms, open-plan offices, amongst others.

This detector is IP20/IP55 rated but can be installed with a deep IP65 waterproof box (072921). You can also change its housing from white to black (072990). (Accessories sold separately).

This detector is manufactured to high-quality and performance standards, with the aim of achieving maximum energy efficiency whilst respecting the environment throughout the manufacturing process.

The detector is made from UV-resistant plastic, ensuring greater durability.

This detector model has been designed to be a versatile product, as it can be installed flush-mounted using its clips (springs) or surface-mounted using the supplied box; furthermore, the detector body itself features pre-drilled holes so that it can be fixed directly to a recessed box using screws.



## Technical Summary

Detector Product Code	iMS Multi-4 360° Presence WHI – 072488 iC
Accessory Product Code	iMS Multi BLK Housing - 072990
Accessory Product Code	iMS Multi Mounting Box AP/UP IP65 WHI - 072921
Sensor Type	Infrared
Lens Type	Multi-lens – emits a greater number of beams per square metre
Power	2000W (incandescent and fluorescent bulbs), 1000W (energy-saving and LED bulbs)
Voltage	220V/AC-240V/AC / 50HZ
Detection Angle	360°
Detection Range	Presence máx. 6m   Tangential máx. 20m
Type of Protection	IP20/IP55/IP65
Twilight Regulation	5 - 200Lux (Adjustable)
Time Adjustment	10seg a 30min
Ideal Installation Height	2 – 12m ceiling   1.8 – 3m wall
Application	Ceiling and wall
Measures	Ø105mm x 58.7mm
Certification	CE
Command	Includes command RC3 - 072709

### Detection Area

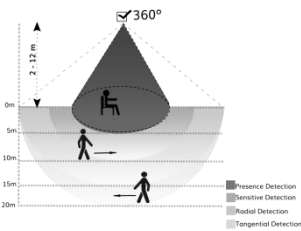

### Detection Diagram

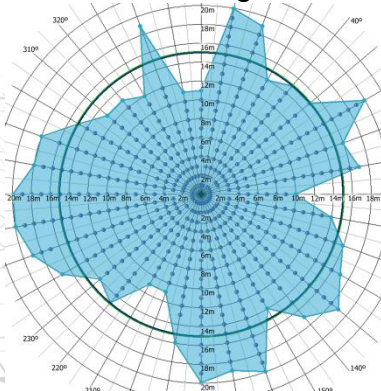

### Wiring Diagram

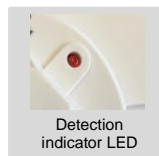
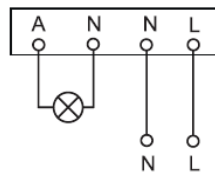

Detection indicator LED



Inc RC3

### Technical Drawing

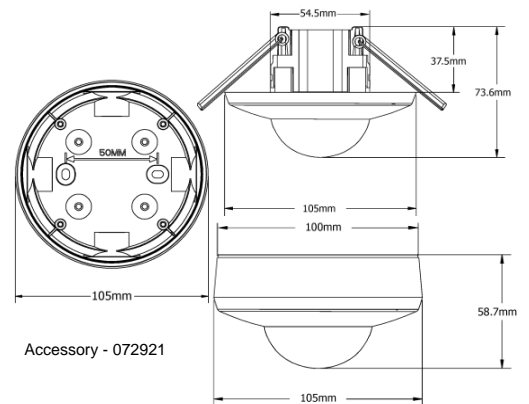

Accessory - 072921

### Technical Summary



### Product Code



5 600244 072488 >



Multi-PRO Range  
★★★★★



## iMS Multi 360° HF Effective Presence WHI

Presence detector with a high-frequency sensor for flush-mounted or surface-mounted installation on walls and ceilings.

This presence detector with a high-frequency sensor is an ergonomic and versatile device suitable for a wide range of applications, as it can be installed either flush-mounted or surface-mounted.

It utilises high-frequency technology, yet its detection mechanism is innovative in that it enables effective presence detection. This effective presence detection enables the detection of visible or invisible movements, such as a person's breathing, heartbeat or even blood flow. We can confidently state that it is a presence detector that detects all movements, whether minor or almost imperceptible. Examples: walking, running, nodding, moving a finger, breathing.

It works by emitting short-wave signals and then receiving the echo reflected from the walls and adjacent objects. Any movement within the detection area is registered by the sensor in fractions of a second due to the change in the echo signal and triggers the device immediately. After an individually adjustable period of inactivity, it returns to its initial settings. It allows adjustments via DIP switches for lux levels, time and sensitivity (distance).

It is ideal for installation on the ceiling or wall. It is the perfect solution for areas with minimal movement, such as classrooms, meeting rooms, offices, hotel rooms, hospitality venues, hospital wards and care homes, ensuring that light/power is only supplied when people are present.

It does not penetrate obstacles made of iron, sheet metal, concrete or other materials of high density and thickness.



# Presence Detectors

Please note that, due to its detection technology, it detects moving liquids as well as moving air masses. It is designed in such a way as to facilitate programming even after installation, as the programming controls are accessible on the detector itself, even when it is already in place. Simply twist off the cover to reveal the programming controls.

Its flat shape makes the product more user-friendly and gives it a more appealing design.

This detector is manufactured to high standards of quality and performance, with the aim of achieving maximum energy efficiency whilst respecting the environment throughout the manufacturing process.

Made from UV-resistant plastic for greater durability.

## Technical Summary

Product Code	iMS Multi 360° HF Effective Presence WHI - 072808
Sensor Type	High Frequency
Power	2000W (incandescent and fluorescent bulbs), 1000W (energy-saving and LED bulbs)
Voltage	220V/AC-240V/AC / 50HZ
Detection Angle	360°
Detection Range	Effective Presence max. 4m   Tangential max. 5.4m
Type of Protection	IP20/IP54
Twilight Regulation	<10 30 100 Dia (24H) - Adjustable
Time Adjustment	10seg - 15min
Ideal Installation Height	2.2m - 4m Ceiling   1.5m - 1.8m wall
Application	Ceiling and wall
Measures	Ø93mm x 36.5mm
Certification	CE

### Wiring Diagram

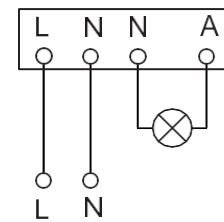

### Technical Drawing

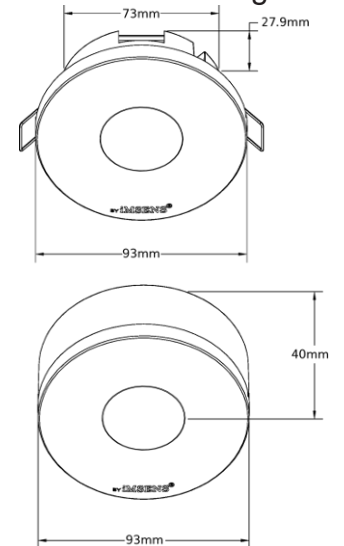

### Detection Diagram

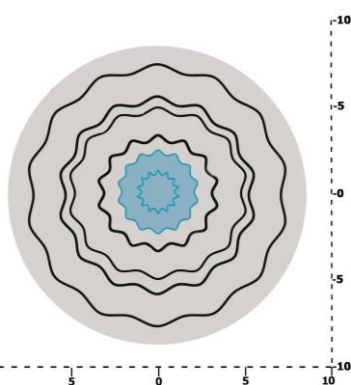

### Detection Area

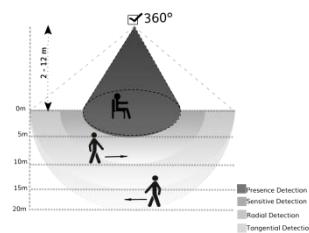

Technical Summary



Product Code





Multi-PRO Range  
★★★★★

## iMS Multi-4 360° DualTech Presence WHI

Dual-technology presence detector for flush-mounted or surface-mounted installation on ceilings and walls.

The presence detector features four infrared pyroelectric sensors and an acoustic sensor – in other words, dual technology (infrared and acoustic) – with a 360° coverage angle and a range of up to 6 metres for direct detection and 20 metres for indirect detection. It is suitable for a wide range of applications, as it can be installed either flush-mounted or surface-mounted, thanks to the accessories included: the springs and the surface-mounted box. It is an ergonomic and versatile detector, suitable for ceiling and wall mounting.

This detector is IP20/IP55 rated but can be installed with a deep IP65 waterproof box (072921). You can also change its housing colour from white to black (072990). (Accessories sold separately).

The RC4 remote control is included with the detector and comes with pre-set programmes. All programming is carried out via this remote. The 4 pre-set programmes are: D/S M1 – acoustic function, which, when selected, will switch the light on if sound is detected; D/S M2 – acoustic or PIR function, which, when selected, will switch the light on if sound is detected, or if movement is detected; D/S M3 – simultaneous acoustic and PIR function, which, when selected, will cause the light to switch on only if sound and movement are detected at the same time; and D/S OFF, which is the free function, disables the other three functions and allows the detector to be configured by adjusting time, sensitivity and lux levels.

In this mode, the sensor will function as a standard presence detector. This sensor has a high switching capacity, enabling it to handle heavy loads.

It is the ideal product for locations where movement is minimal and the light needs to remain on, but where there is no movement, only sound, such as: classrooms, technical rooms, doctors' surgeries, clinics, beauty salons, gyms, changing rooms, meeting rooms, open-plan offices, amongst others.



PIR



Acoustic



2000W



1000W



360°



6-20m



10-100lux



10s-30min



Inc. RC4



IP 20/55/65



# Presence Detectors

The product has been designed to offer a high degree of versatility in its application. It is ideal for situations where the light needs to be activated via one or both detection methods, and where its continuity can be detected by one or both. Consequently, the product is versatile not only in terms of how it is used but also in terms of detection, allowing the desired priority to be set according to requirements.

This detector is manufactured to high-quality and performance standards, with the aim of achieving maximum energy efficiency whilst respecting the environment throughout the manufacturing process.

The detector is made from UV-resistant plastic, ensuring greater durability.

## Technical Summary

Detector Product Code	iMS Multi-4 360° DualTech Presence WHI - 072495 iC
Accessory Product Code	iMS Multi BLK Housing - 072990
Accessory Product Code	iMS Multi Mounting Box AP/UP IP65 WHI - 072921
Sensor Type	Dual technology (Infrared + Acoustic)
Lens Type	Multi-lens – emits a greater number of beams per square metre
Power	2000W (incandescent and fluorescent bulbs), 1000W (energy-saving and LED bulbs)
Voltage	220V/AC-240V/AC / 50HZ
Detection Angle	360°
Detection Range	Presence max. 6m   Tangential max.20m
Type of Protection	IP20/IP55/IP65
Twilight Regulation	10 – 100Lux (Adjustable)
Time Adjustment	10seg a 30min
Ideal Installation Height	2m - 17m ceiling   1.8m - 5m wall
Application	Ceiling and wall
Measures	Ø105mm x 58.7mm
Certification	CE
Command	Includes command RC4 - 072716

## Technical Drawing

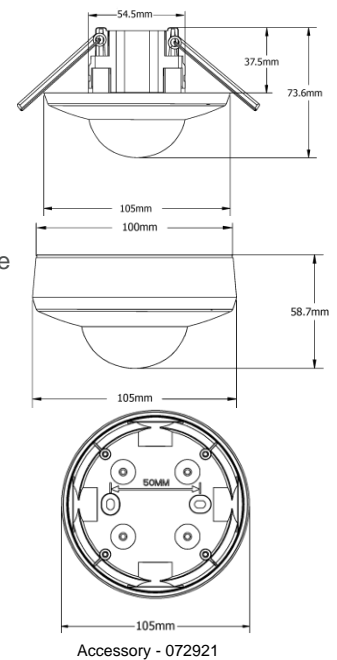

## Wiring Diagram

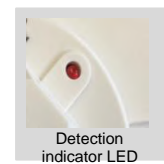
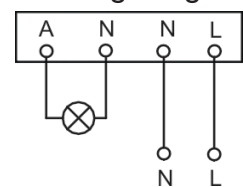

## Detection Area

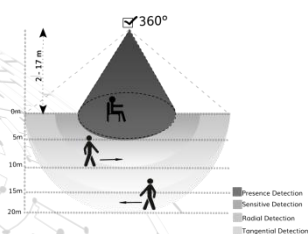

## Detection Diagram

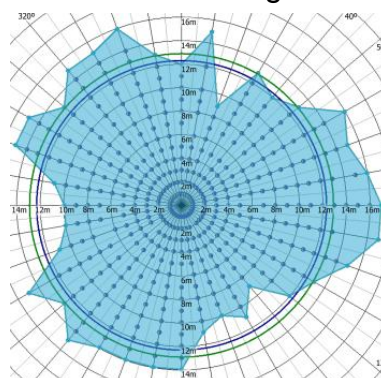

## Technical Summary



## Product Code



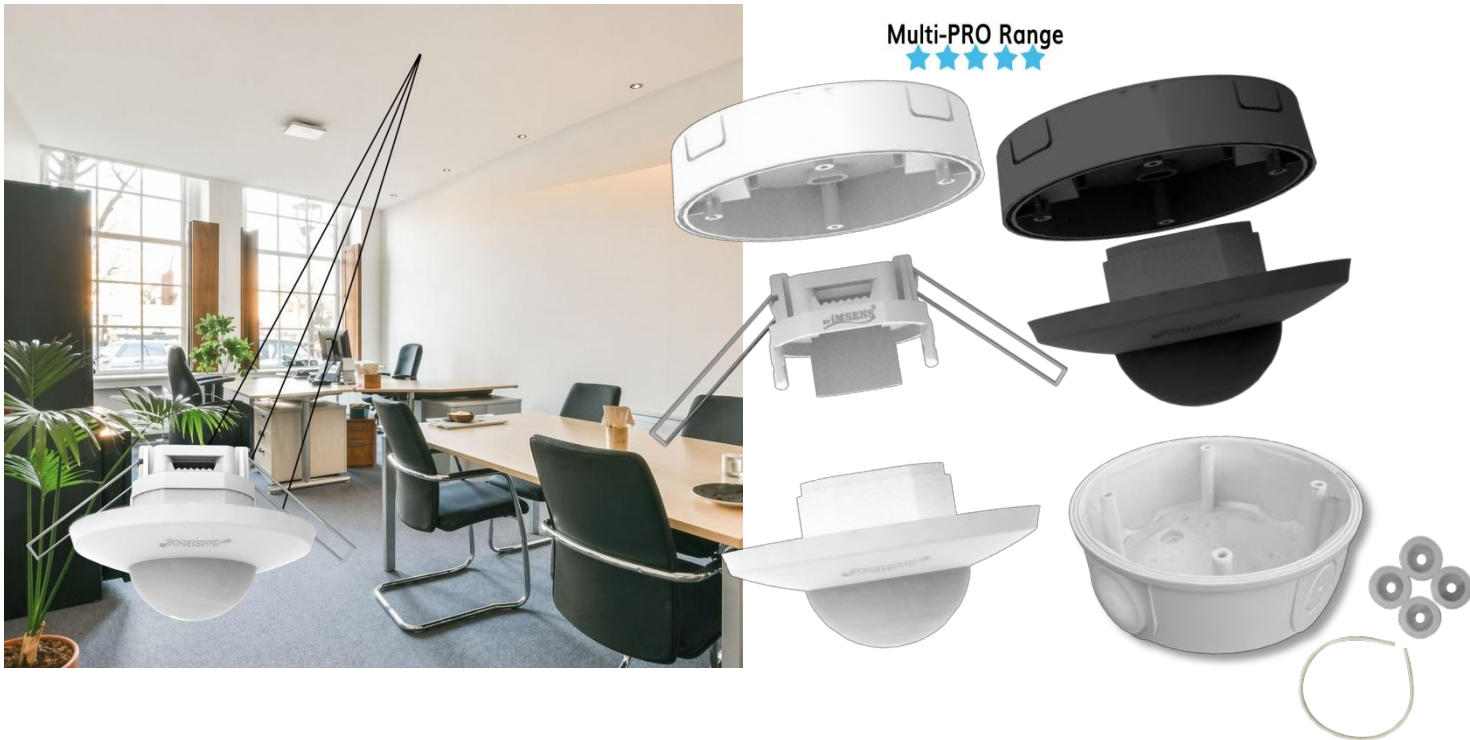

## iMS Multi-3 360° 0-10V Dim Presence WHI

DIM presence detector for flush-mounted or surface-mounted installation.

This is a presence detector featuring three infrared pyro sensors and a dimming function, designed for multi-purpose applications as it can be installed either flush-mounted or surface-mounted, thanks to the accessories included: the mounting clips and the surface-mounting box. Its versatility for use in construction sites or small areas, combined with equipment featuring dimmable 0-10V electronic ballasts, enables low-cost energy savings. It is an ergonomic and versatile detector, suitable for ceiling and wall mounting. This detector is IP20/IP55 rated but can be installed with a deep IP65 waterproof box (072921). You can also change its housing colour from white to black (072990). (Accessories sold separately).

It allows programming via the potentiometers or via the RC6 remote control, sold separately.

The remote control enables a wide range of changes, programming and adjustments, amongst other functions. You can, for example, select pre-defined scenarios as well as one of four adjustable modes: M1-AT = Automatic (occupancy function + 'daylight harvesting'), M2-PM = PIR + Moon (Moonlight) Occupancy function during moonlight (twilight), M3-PC (occupancy without "daylight harvesting") or M4-LC (Lux + Controls (only the "daylight harvesting" function))). The factory settings can be changed using the remote control.

Selecting the most appropriate mode or preset scenario, or adjusting the settings accordingly, will help to save energy, as lighting can be adjusted to make the most of natural light, thereby avoiding the use of more artificial light than is necessary and extending the lifespan of the connected equipment, thus achieving overall energy efficiency.



# 0-10V Presence Detectors

This is the ideal product for areas with low footfall where you wish to create different lighting scenarios, such as: classrooms, technical rooms, doctors' surgeries, consultation rooms, auditoriums, screening rooms, open-plan offices, and more. Its high protection rating safeguards it against the elements. This luminaire is manufactured to exacting high-quality and performance standards, with the aim of achieving maximum energy efficiency whilst respecting the environment throughout the manufacturing process. It is made from UV-resistant plastic for greater durability.

## Technical Summary

Detector Product Code	iMS Multi-3 360° 0-10V Dim Presence WHI - 072815 C
Accessory Product Code	iMS Multi Mounting Box AP/UP IP65 WHI - 072921
Accessory Product Code	iMS Multi BLK Housing - 072990
Sensor Type	Infrared
Lens Type	Multi-lens – emits a greater number of beams per square metre
Power	2000W (incandescent and fluorescent bulbs), 1000W (energy-saving and LED bulbs)
Voltage	Input L/N: 220-240V AC/50HZ Live AC output A/N: 220-240V AC/50HZ, 300W 0 – 10 V Voltage Output: ± 0 – 10 V
Detection Angle	360°
Detection Range	Presence max. 6m   Tangential max.20m
Type of Protection	IP20/IP55/IP65
Twilight Regulation	3-2000Lux (Adjustable)
Time Adjustment	10seg a 30min
Ideal Installation Height	2 – 12m ceiling   1.5 – 5m wall
Application	Ceiling and wall
Measures	Ø105mm x 58.7mm
Certification	CE
Command	Remote Control RC6 - 072846 (Sold separately)

## Technical Drawing

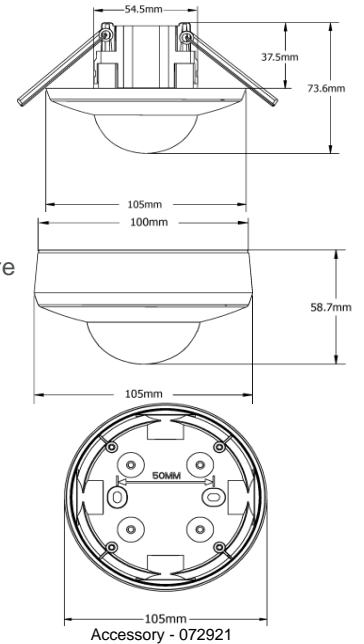

## Wiring Diagram

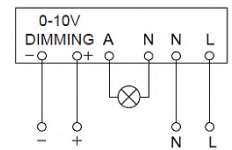

0-10V

Not Incl. RC6

## Detection Area

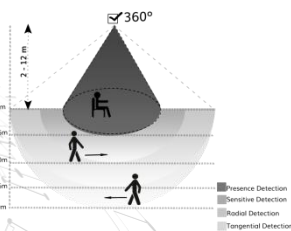

## Detection Diagram

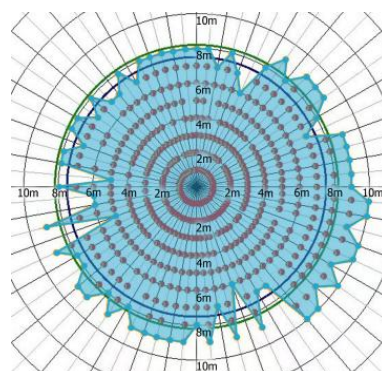

## Technical Summary



Product Code





Multi-PRO Range



## iMS Multi-3 360° Dali2 APC Presence WHI

Presence detector with DALI2 APC interface for recessed or surface mounting on walls or ceilings.

The presence detector with DALI2 APC (Application Controller) interface, with a 360° angle and a long range, is ideal for multi-purpose applications as it allows for recessed or surface mounting, thanks to the included accessories: springs and surface mounting box. This detector is IP20/IP55 rated but can be installed with a deep IP65 waterproof housing (072921). You can also change its housing from white to black (072990). (Accessories sold separately).

It allows for ceiling and wall mounting, making it ideal for locations where movement is low (where a presence detector is most suitable) and where it is necessary to manage the desired light flux in the work environment by compensating for the light from the luminaires, dimming the light intensity as desired. Ideal for locations such as: classrooms, technical rooms, medical offices, consulting rooms, auditoriums, projection rooms, open spaces, among others. Its DALI2 APC technology allows interconnection with other lighting equipment of the same DALI technology, obtaining effective control of all lighting equipment, allowing for efficient and permanent management, saving all your resources and extending their lifespan. DALI2 APC eliminates the need for an additional bus source and separate control unit, making installation significantly faster and simpler. This BYiMSENS DALI2 APC detector can control various equipment and lighting groups, operating autonomously without the need for a central system. The SVA installation is low cost. In short, it is a DALI2 Single Master APC (SMAC) detector that controls broadcast equipment without the need for an external controller.

It is an ergonomic and versatile detector that also works with the use of the RC6 remote control (sold separately).



DALI-2



# DALI2 APC Detectors

The remote control allows for a wide range of changes, programming, adjustments, and more. For example, you can choose predefined scenarios as well as one of four adjustable modes: M1-AT = Automatic (occupancy function + "daylight harvesting"), M2-PM = PIR + Moon (Moonlight) Occupancy function during moonlight (twilight), M3-PC (occupancy without "daylight harvesting") or M4-LC (Lux + Controls (only the "daylight harvesting" function)). Factory values can be changed via the remote control. Choosing the most suitable mode or predefined scenario, or adjusting the characteristics, will allow for energy savings, since light compensation can be made, making the most of natural light, thus avoiding unnecessary artificial light consumption and extending the lifespan of connected equipment, thus achieving overall energy efficiency. There is also the option of using a push-button switch, which makes it easier for the user to control their lighting in real time to optimize their needs: turning the sensor on or off directly, without using the remote control. The detector is made of UV-resistant plastic, thus allowing for greater durability. It is a detector manufactured under high-quality and high-performance standards, in order to achieve maximum energy efficiency, respecting the environment in its manufacturing process.

## Technical Summary

Detector Product Code iMS Multi-3 360° Dali2 APC Presence WHI – 072501 C

Accessory Product Code iMS Multi BLK Housing - 072990

Accessory Product Code iMS Multi Mounting Box AP/UP IP65 WHI - 072921

Sensor Type Infrared

Lens Type Multi-lens – emits a greater number of beams per square metre

Voltage Input L/N: 220-240V AC/50Hz  
Push-DIM: Push button with 250 VAC  
DA+ / DA-: 14 – 18 VDC  
Overload up to 25 drivers

Detection Angle 360°

Detection Range Presence max. 6m | Tangential max.20m

Type of Protection IP20/IP55/IP65

Twilight Regulation 3-2000Lux (Adjustable)

Time Adjustment 10seg a 30min

Ideal Installation Height 2m – 12m ceiling | 1.5m – 5m wall

Application Ceiling and wall

Measures Ø105mm x 58.7mm

Certification CE

Command Remote Control RC6 - 072846 (Sold separately)

## Technical Drawing

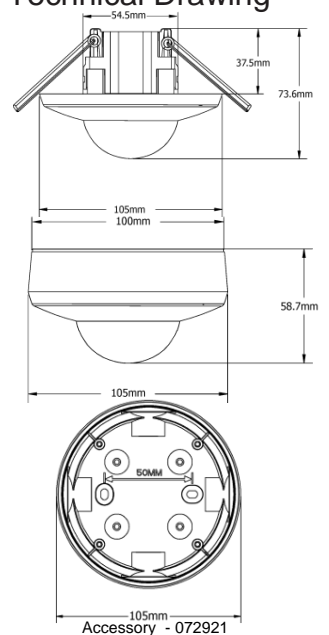

## Wiring Diagram

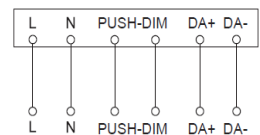

## Technical Summary



Product Code



## Detection Area

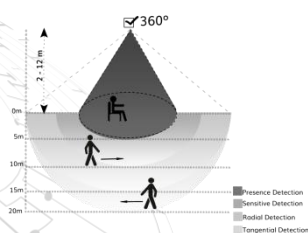

## Detection Diagram

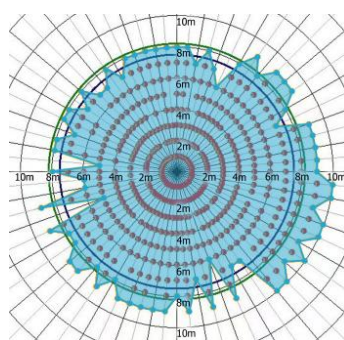



## IMS Multi 360° Dali2 APC Mini Presence WHI

Presence detector with DALI2 APC interface for recessed or surface mounting on walls or ceilings.

The DALI2 APC (Application Controller) presence detector has a 360° angle and is ideal for multi-purpose applications as it allows for recessed or surface mounting thanks to the included accessories: springs and surface mounting box. It allows for ceiling and wall installation, making it ideal for small spaces where it's necessary to manage the desired luminous flux in the work environment by compensating for the light from the luminaires, dimming the light intensity as desired. Ideal for locations such as: technical rooms, medical offices, consulting rooms, corridors, among others. Its DALI2 APC technology allows interconnection with other lighting equipment of the same technology, obtaining effective control of all lighting equipment, enabling efficient and permanent management, saving resources and extending their lifespan. DALI2 APC eliminates the need for an additional busbar and separate control unit, making installation significantly faster and simpler. This BYiMSENS DALI2 APC detector can control various equipment and lighting groups, operating autonomously without the need for a central system. The SVA installation is low cost. In short, it is a DALI2 Single Master APC (SMAC) detector that controls broadcast equipment without the need for an external controller.

It is an ergonomic and versatile detector and works with the use of the RC6 remote control (included). The remote control allows for a wide range of SVA programming changes, adjustments, and more.



**DALI-2**



# DALI2 APC Detectors

For example, you can choose predefined scenarios as well as one of four adjustable modes: M1-AT = Automatic (occupancy function + “daylight harvesting”), M2-PM = PIR + Moon (Moonlight) Occupancy function during moonlight (twilight), M3-PC (occupancy without “daylight harvesting”) or M4-LC (Lux + Controls (only the “daylight harvesting” function)). Factory values can be changed via the remote control to meet the user's needs depending on the application area.

Choosing the most suitable Mode or predefined scenario, or adjusting the characteristics, will allow for energy savings, since light compensation can be made, making the most of natural light, thus not spending more artificial light than necessary and extending the durability of connected equipment, thus achieving overall energy efficiency.

The detector is made of UV-resistant plastic, thus allowing for greater durability. It is a detector manufactured under high quality and performance standards. In order to achieve maximum energy efficiency, while respecting the environment in its manufacturing process.

## Technical Summary

Product Code	iMS Multi 360° Dali2 APC Mini Presence WHI – 072662 iC
Sensor Type	Infrared
Lens Type	Multi-lens – emits a greater number of beams per square metre
Voltage	Input L/N: 220-240V AC/50Hz DA+ / DA-: 14 – 18 VDC Overload up to 25 drivers
Detection Angle	360°
Detection Range	Presence max. 4m   Tangential max.7m
Type of Protection	IP20/IP55
Twilight Regulation	3-2000Lux (Adjustable)
Time Adjustment	30seg a 30min
Ideal Installation Height	2m – 4m ceiling   1.5m – 2.5m wall
Application	Ceiling and wall
Measures	Ø74mm x 46.5mm
Certification	CE
Command	Includes command RC6 - 072846

### Technical Drawing

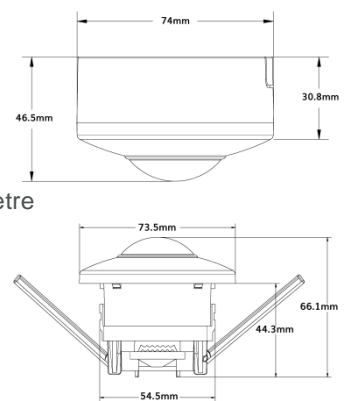

### Wiring Diagram

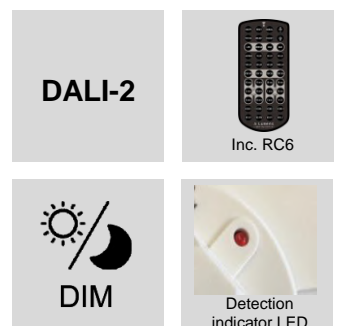
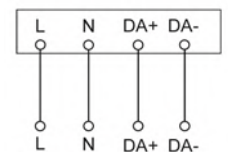

### Detection Area

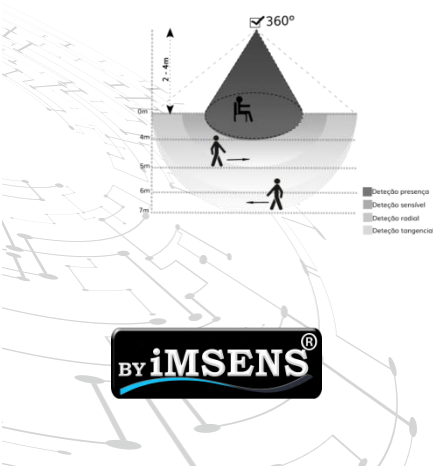

### Detection Diagram

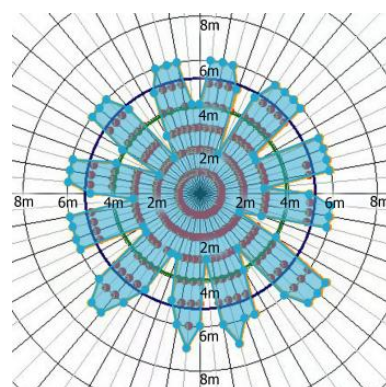

### Technical Summary



### Product Code



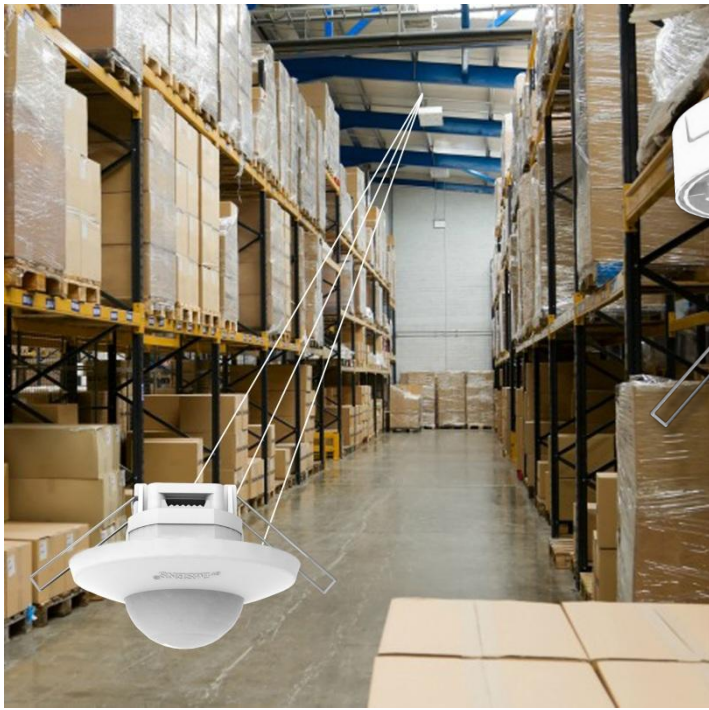

Multi-PRO Range  
★★★★★

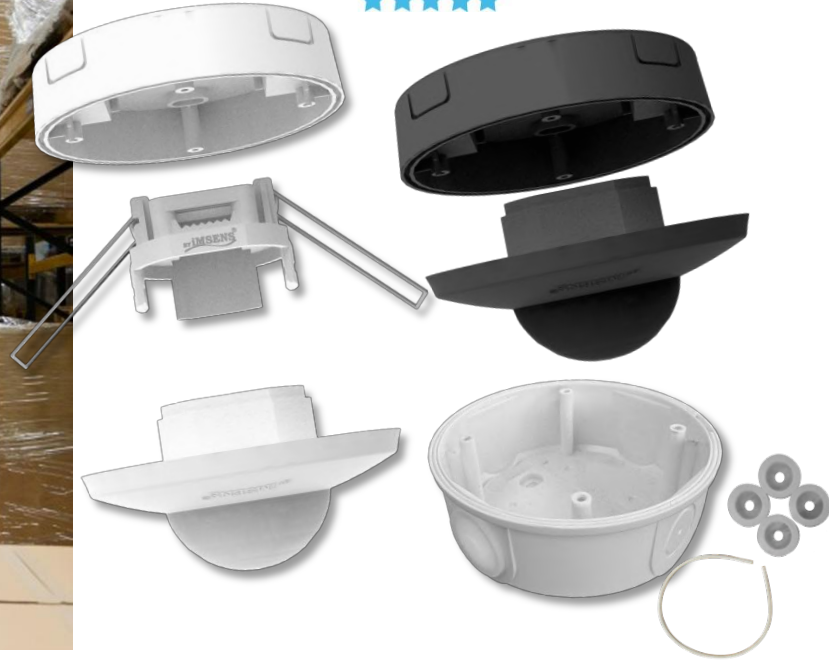

## iMS Multi-4 360° KNX Presence WHI

Presence detector with KNX interface for flush-mounted or surface-mounted installation on walls or ceilings.

The KNX-compatible presence detector, with a 360° detection angle and a long range, is suitable for a wide range of applications as it can be installed either flush-mounted or surface-mounted, thanks to the accessories included: the springs and the surface-mounting box. It is an ergonomic and versatile detector, suitable for ceiling and wall installation. This detector is IP20/IP55 rated but can be installed with a waterproof IP65 flush-mounted box (072921). You can also change its housing colour from white to black (072990). (Accessories sold separately).

It is the ideal product for locations where movement is minimal and control via home automation is required.

This detector is manufactured to high-quality and performance standards, designed to achieve maximum energy efficiency whilst respecting the environment throughout its manufacturing process.

The detector is made from UV-resistant plastic, ensuring greater durability.

Coming soon; currently in development.



KNX



360°



IP  
20/55/65

## Technical Summary

Detector Product Code	iMS Multi-4 360° KNX Presence WHI - 072000
Accessory Product Code	iMS Multi BLK Housing - 072990
Accessory Product Code	iMS Multi Mounting Box AP/UP IP65 WHI - 072921
Sensor Type	Infrared
Lens Type	Multi-lens – emits a greater number of beams per square metre
Voltage	30V-DC via KNX bus
Detection Angle	360°
Detection Range	Presence max. 6m   Tangential max. 20m
Type of Protection	IP20/IP55/IP65
Twilight Regulation	3-2000Lux (Adjustable)
Time Adjustment	1s – 4h
Ideal Installation Height	2 – 17m ceiling   1.8 – 5m wall
Application	Ceiling and wall
Measures	Ø105mm x 58.7mm
Certification	CE

### Detection Area

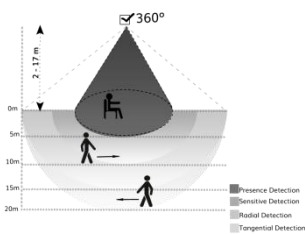

### Detection Diagram

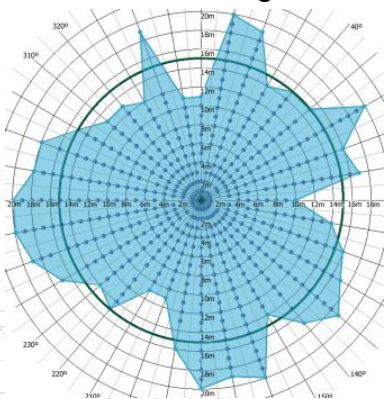

### Technical Drawing

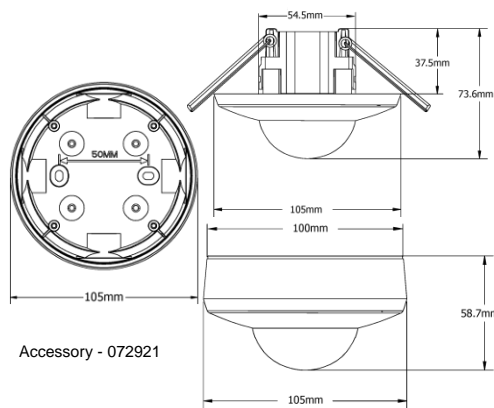

**KNX**

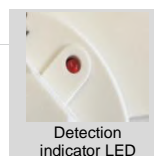

Detection indicator LED

Technical Summary



Product Code



# Proximity Sensors





04.

# Proximity Sensors

iMS Proxim Sensor ON/OFF WHI - 072358



Universal Range  
★★★★★



## IMS Proxim Sensor ON/OFF WHI

Short-range IR sensor.

It is a short-range IR (infrared) sensor. In other words, the system itself operates using easily detectable signals, as they are of the 'yes' or 'no' type.

The sensor has quick-connect terminals, making installation straightforward. Distances of up to 6 centimetres can be detected with ease.

The ON/OFF function is controlled by the proximity of obstacles. When an obstacle is placed within the detection area, the sensor detects it and switches the light off. The light will remain on as long as the sensor does not detect anything within that detection range.

Items it can detect: all types of solid materials, for example, wood, metal, glass, brick, amongst others.

This sensor is manufactured to high-quality and performance standards, designed to achieve maximum energy efficiency whilst respecting the environment throughout its manufacturing process.

Ideal for use inside cupboards, drawers, wardrobes, kitchen cupboards, filing cabinets, and more.



## Technical Summary

Product Code	iMS Proxim Sensor ON/OFF WHI - 072358
Sensor Type	IR Proximity
Voltage	220V/AC-240V/AC / 50HZ
Detection Range	Max. 6cm
Type of Protection	IP20/IP65
Application	Drawers/cupboards
Measures	90.2mm x 36.1mm   Cable 2m
Certification	CE

Wiring Diagram

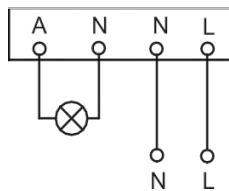

Technical Drawing

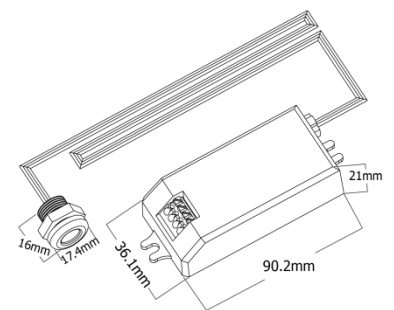

Technical Summary



Product Code



5 600244 072358 >

# Twilight Photoceils





05.

## Twilight Photocells

iMS Alpha Twilight WHI - 818478

iMS Alpha Twilight BLK - 072402

iMS Alpha Twilight Time WHI - 072532



Universal Range  
★★★★★



## iMS Alpha Twilight WHI / BLK

A twilight switch that allows for automatic light control.

This is the ideal twilight switch for controlling lighting systems designed to illuminate house facades, grounds, shop windows, courtyards, gardens, illuminated signs and billboards at night. The Alpha detects ambient light levels and automatically switches the lighting on at dusk—more precisely, when the pre-set twilight threshold is reached—and switches it off again at dawn.

The Alpha features quick connectors, making installation easy. It has a high switching capacity, enabling it to handle heavy loads.

It is suitable for both indoor and outdoor use thanks to its high protection rating (IP54), which protects it from the elements.

It is a sensor manufactured to high-quality and performance standards, designed to achieve maximum energy efficiency whilst respecting the environment throughout its manufacturing process.

The twilight switch is made from UV-resistant plastic, ensuring greater durability.



2000W



1000W



10-250lux

IP  
54

## Technical Summary

White Product Code	iMS Alpha Twilight WHI - 818478
Black Product Code	iMS Alpha Twilight BLK - 072402
Sensor Type	Twilight Photocells
Power	2000W (incandescent and fluorescent bulbs), 1000W (energy-saving and LED bulbs)
Voltage	220V/AC-240V/AC / 50HZ
Type of Protection	IP54
Twilight Regulation	10–250Lux
Application	Wall
Measures	101.7mm x 70.3mm x 31.5mm
Certification	CE

### Wiring Diagram

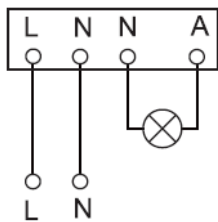

	< 10LUX	> 40 LUX	< 10 LUX	> 80 LUX	< 150 LUX	> 250 LUX
	ON	OFF	-	-	-	-
	-	-	ON	OFF	-	-
	-	-	-	-	ON	OFF

### Technical Drawing

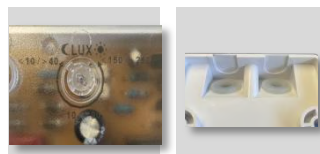
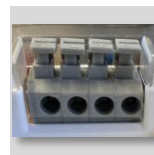
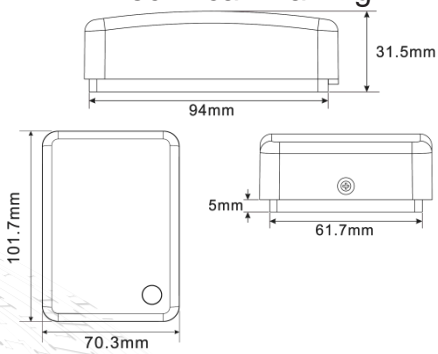

### Technical Summary



White



Black

### Product Code



White



Black



Multi-PRO Range  
★★★★★



## iMS Alpha Twilight Time WHI

Twilight switch with timer for automatic light control.

The twilight switch with timer that turns night into day. This switch turns the lights on depending on the ambient light levels. The microprocessor-controlled twilight timer is ideal when you wish to illuminate an area whilst setting its operating window to switch off in advance of sunrise. However, this sensor has a DD function which, when programmed, will act as a standard twilight switch.

It is ideal for shop windows, commercial signage or other surfaces.

The variable economy night mode and the option to choose whether the light is 'on or off in the morning' are particularly useful if the light, although it needs to be controlled by twilight, is not required during a specific period of the night. In this mode, the light switches on at dusk, then switches off at night within an adjustable time window and switches on again in the morning, if desired, remaining off during the day.

The Alpha Time features quick connectors, making installation straightforward.

It can be used both indoors and outdoors thanks to its high protection rating (IP54), which shields it from the elements.

It is a sensor manufactured to exacting standards of quality and performance, designed to achieve maximum energy efficiency whilst respecting the environment throughout its manufacturing process.

The twilight switch is made from UV-resistant plastic, ensuring greater durability.



2000W



1000W



10 lux ON  
40 lux OFF



1-12h  
D-D

IP  
54

## Technical Summary

Product Code	iMS Alpha Twilight Time WHI - 072532
Sensor Type	Twilight Photocells
Power	2000W (incandescent and fluorescent bulbs), 1000W (energy-saving and LED bulbs)
Voltage	220V/AC-240V/AC / 50HZ
Type of Protection	IP54
Twilight Regulation	10-40Lux
Time Adjustment	1 - 12h / D-D
Application	Wall
Measures	101.7mm x 70.3mm x 31.5mm
Certification	CE

	<20 LUX	<10 LUX	Time   OFF	>40 LUX
	ON		D-D	
		ON	1 H	OFF
		ON	3 H	OFF
			5 H	OFF
		ON	7 H	OFF
		ON	12 H	OFF

### Wiring Diagram

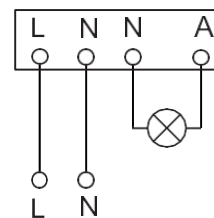

### Technical Drawing

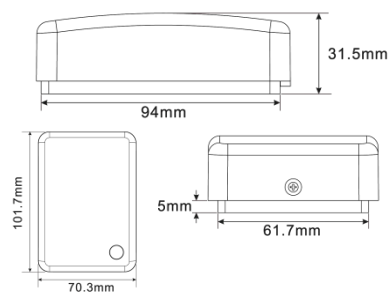

### Technical Summary



Product Code



5 600244 072532

# Lighting





# 06.

## Lighting with a PIR sensor

iMSL 360° Urano Led 20W WHI - 072341

iMSL 360° Multi Downlight Sol 18W WHI / BLK / SIL - 072518



Universal Range  
★★★★★



## iMSL 360° Urano Led 20W WHI

LED ceiling light with infrared sensor for ceiling or wall mounting.

LED ceiling light with a simple design for installation on the ceiling or wall.

The simplest way to light your home or space using modern technology is with the BYiMSENS® ceiling light. The latest sensor technology automatically switches the light on at dusk as soon as it detects movement combined with temperature. If no movement is detected, the light switches off again after a pre-set time has elapsed.

It provides security, comfort and energy savings through automatic light switching. It is the ideal product for hallways, porches, apartment entrances, stairwells, and more. This ceiling light is manufactured to high-quality and performance standards to achieve maximum energy efficiency, whilst respecting the environment throughout the manufacturing process.



## Technical Summary

Product Code	iMSL 360° Urano Led 20W WHI - 072341
Sensor Type	Infrared
Power	20W
Lumens	1600lm - 80lm/W
Kelvin	4000K
Voltage	220V/AC-240V/AC / 50HZ
Detection Angle	360°
Detection Range	Max. 6m
Type of Protection	IP20 / IK07
Twilight Regulation	10 - 2000Lux (Adjustable)
Time Adjustment	10seg a 3min
Ideal Installation Height	2.2m - 4m Ceiling   1.8m - 4m wall
Application	Ceiling and wall
Measures	Ø293mm
Certification	CE

Detection Area

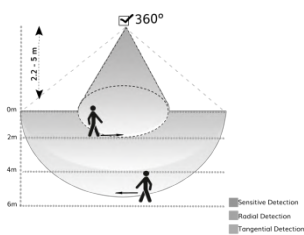

Wiring Diagram

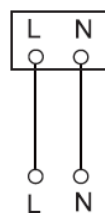

Technical Drawing

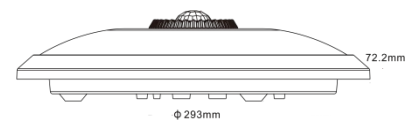

Detection Diagram

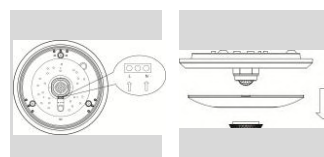
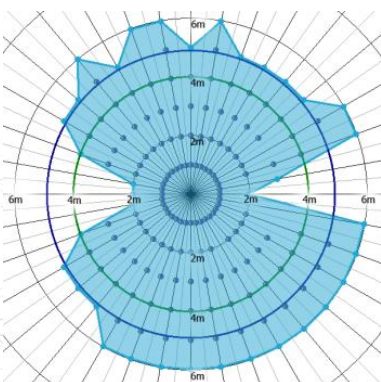

Technical Summary



Product Code



5 600244 072341 >



Multi-PRO Range  
★★★★★



## iMSL 360° Multi Downlight Sol 18W WHI / BLK / SIL

LED Downlight with an infrared sensor, suitable for surface-mounted or recessed installation in ceilings or walls.

The simplest way to light your home and your space using modern technology is with the BYIMSENS® downlight. State-of-the-art sensor technology automatically switches the lighting on at dusk as soon as it detects movement combined with temperature. If no movement is detected, the lighting switches off again after a pre-set time has elapsed.

It provides security, comfort and energy savings through automatic light switching. You can choose to programme the sensor or switch it off, in which case the ceiling light functions as a conventional lamp.

It allows you to adjust the Kelvin rating: the colour temperature can be set using a switch on the front of the light fitting; simply remove the cover by unclipping it. The options are 3000K (warm white), 4000K (natural white), 6000K (cool white) or SWITCH – switch (this works by pressing a switch, and each press of the switch changes the Kelvin setting).

You can also choose the colour of the ring: white / black / grey, all included. As the ring colour can be changed, this makes it the ideal product for hallways, living rooms, leisure areas, bathrooms, apartment entrances, stairwells, and more.

This downlight is manufactured to exacting standards of high quality and performance, in order to achieve maximum energy efficiency, whilst respecting the environment throughout its manufacturing process.



PIR



18W



LM  
1900lm



3000K  
4000K  
6000K  
CCT



120°/360°



6m



10-2000lux



30s-120s



IP  
20



IK07



## Technical Summary

Product Code	iMSL 360° Multi Downlight Sol 18W WHI / BLK / SIL - 072518
Sensor Type	Infrared
Power	18W
Lumens	1900lm – 105lm/W
Kelvin	3000K / 4000K / 6000K
Voltage	220V/AC-240V/AC / 50HZ
Detection Angle	120° wall / 360° ceiling
Detection Range	Max. 6m
Type of Protection	IP20 / IK07
Twilight Regulation	10 - 2000Lux (Adjustable)
Time Adjustment	30seg a 2min
Ideal Installation Height	2.2m – 5m ceiling   1.7m – 5m wall
Application	Ceiling and wall
Measures	Ø230mm
Certification	CE

Detection Area

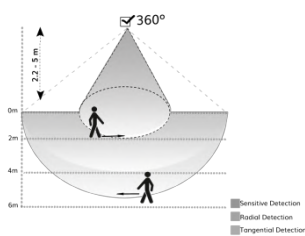

Wiring Diagram

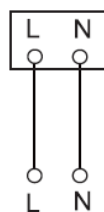

Technical Drawing

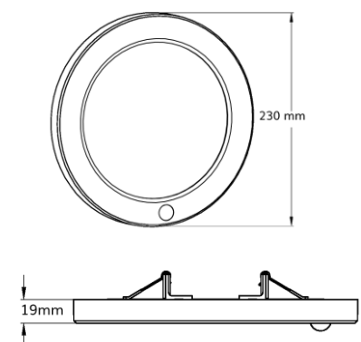

Detection Diagram

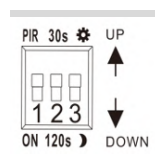
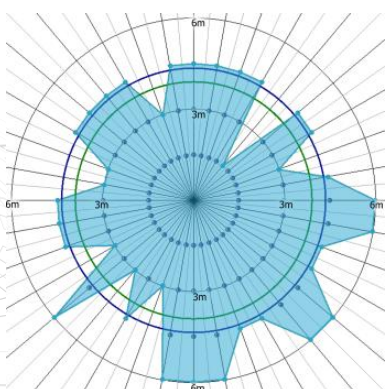

Technical Summary



Product Code



# Lighting





07.

# Lighting with High Frequency Sensor

iMSL 360° Neptuno Led 13W WHI - 072105

iMSL 360° Venus E27 PMMA WHI - 818423

iMSL Multi Ceres 12W -> 25W CCT PC WHI - 072679



Universal Range  
★★★★★



## iMSL 360° Neptuneo Led 13W WHI

LED ceiling light with a high-frequency sensor, suitable for installation on the ceiling or wall.

LED ceiling light with a high-frequency sensor, featuring a simple design for installation on the ceiling or wall.

The innovation lies hidden inside the light. A high-frequency motion sensor greets you and your visitors with light when you enter the detection zone, and switches off again when it is no longer needed. This means you can now enjoy maximum efficiency and the best comfort and well-being even inside buildings.

The high-frequency sensor detects movement instantly through the movement of objects and/or people. It emits short-wave signals and immediately receives the echo reflected from the walls and adjacent objects. Any movement within the detection area is registered by the sensor in a fraction of a second due to the change in the echo pattern, and the light switches on immediately! After an individually adjustable inactivity period, the light switches off automatically.

Intelligence isn't seen, it's felt. The high-frequency sensors can be optimally adapted to requirements thanks to three continuously adjustable controls.

Ideal for corridors, porches, house entrances, apartment entrances, stairwells, and more.

This ceiling light is manufactured to exacting standards of high quality and performance, designed to achieve maximum energy efficiency whilst respecting the environment throughout its manufacturing process.



## Technical Summary

Product Code	iMSL 360° Neptuno Led 13W WHI - 072105
Sensor Type	High Frequency
Power	13W
Lumens	1040lm – 80lm/W
Kelvin	4000K
Voltage	220V/AC-240V/AC / 50HZ
Detection Angle	360°
Detection Range	Max. 10m
Type of Protection	IP54 / IK10
Twilight Regulation	10 - 2000Lux (Adjustable)
Ideal Installation Height	2 – 3.5m ceiling   1.7 – 3.5m wall
Time Adjustment	10seg a 15min
Application	Ceiling and wall
Measures	Ø220mm
Certification	CE

Detection Area

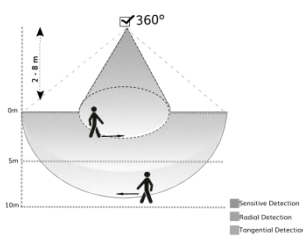

Wiring Diagram

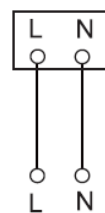

Technical Drawing

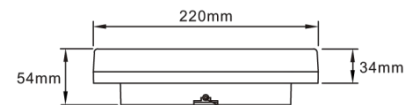

Detection Diagram

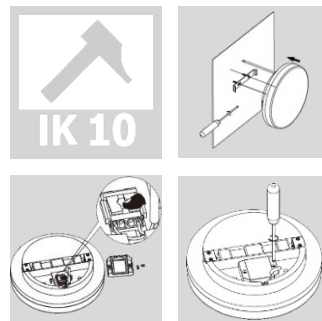
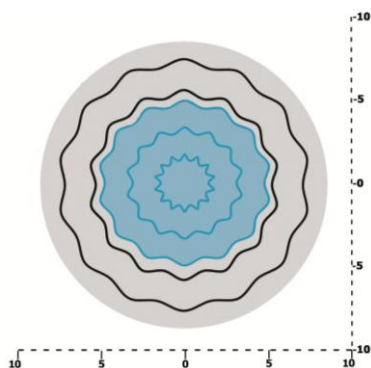

Technical Summary Product Code





Universal Range  
★★★★★



## iMSL 360° Venus E27 PMMA WHI

E27 ceiling light with a high-frequency sensor, suitable for ceiling or wall mounting.

The innovation is hidden inside the lamp! A high-frequency motion sensor that greets you and your visitors with light when you enter the detection zone, and switches off again when it is no longer needed. This means you can now enjoy maximum efficiency and the best possible comfort and well-being even inside buildings.

The high-frequency sensor detects movement instantly via the movement of objects and/or people. The sensor emits short-wave signals and immediately receives the echo reflected from the walls and adjacent objects. Any movement within the detection area is registered by the sensor in a fraction of a second due to the change in the echo pattern, and the light switches on immediately! After an individually adjustable standby time, the light switches off automatically. Intelligence isn't seen, it's felt. The high-frequency technology is concealed inside the luminaire and ensures 'just-in-time' lighting.

The high-frequency sensors can be optimally adapted to requirements thanks to three adjustable settings. They are compatible with E27 bulbs, up to a maximum of 60W.

Ideal for corridors, porches, house entrances, apartment entrances, stairwells, car parks, and more.

This ceiling light is manufactured to exacting standards of high quality and performance, designed to achieve maximum energy efficiency whilst respecting the environment throughout its manufacturing process.



## Technical Summary

Product Code	iMSL 360° Venus E27 PMMA WHI - 818423
Sensor Type	High Frequency
Power	60W/E27
Voltage	220V/AC-240V/AC / 50HZ
Detection Angle	360°
Detection Range	Max. 10m
Type of Protection	IP44 / IK07
Twilight Regulation	3 – 2000Lux (Adjustable)
Time Adjustment	10seg a 12min
Ideal Installation Height	2.5m - 5m ceiling   1.7m - 5m wall
Application	Ceiling and wall
Measures	Ø275mm
Certification	CE
Globe Material	PMMA

Detection Area

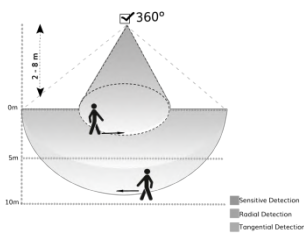

Wiring Diagram

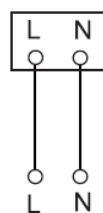

Technical Drawing

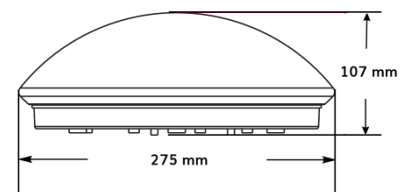

Detection Diagram

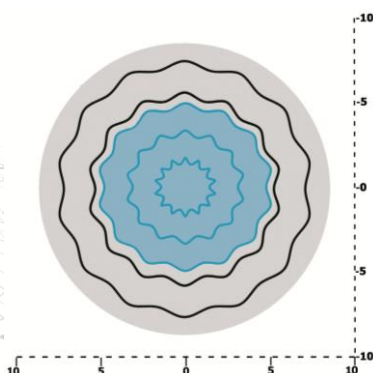

PMMA



Technical Summary



Product Code





Universal Range  
★★★★★



## iMSL Multi Ceres 12W -> 25W CCT PC WHI

LED ceiling light with a high-frequency sensor, suitable for installation on the ceiling or wall.

The innovation lies within the light fitting. It features a high-frequency sensor that switches the light on when someone enters the detection zone and switches it off again when it is no longer needed. The sensor detects movement instantly through the movement of objects and/or people. It emits short-wave signals and immediately receives the echo reflected from the walls and adjacent objects. Any movement within the detection area is registered by the sensor in a fraction of a second due to the change in the echo signal, and the light switches on immediately! After an individually adjustable inactivity period, the light switches off automatically. It is a versatile luminaire in terms of both its application and functionality, and above all its energy efficiency; the colour temperature can be technologically adjusted across 3 scales: 3000K (warm white), 4000K (neutral white) and 6000K (cool white), as well as its lighting output (12W, 18W or 25W) directly on the unit.

Its improved design makes this ceiling light versatile in terms of installation and application for a wide range of uses. It can be used both indoors and outdoors thanks to its high protection rating (IP65), which protects it from the elements. It is a vandal-proof product (IK10) that complies with the required safety standards and is therefore ideal for high-traffic areas and public spaces. It includes a key for use with the vandal-proof screws. This light fitting is manufactured to exacting standards of quality and performance, with the aim of achieving maximum energy efficiency whilst ensuring that its manufacturing process is environmentally friendly.



12W/18W/25W

LM  
2800lm

3000K  
4000K  
6000K  
CCT

360°

10m

10-100 (24h) lux

10s-15min

IP  
65

IK10

BY **iMSENS**®

## Technical Summary

Product Code	iMSL Multi Ceres 12W -> 25W CCT PC WHI - 072679
Sensor Type	High Frequency
Power	12W / 18W / 25W
Lumens	2800lm – 112lm/W
Kelvin	3000K / 4000K / 6000K
Voltage	220V/AC-240V/AC / 50HZ
Detection Angle	360°
Detection Range	Max. 10m (2   5   8   10m) – Adjustable
Type of Protection	IP65 / IK10
Twilight Regulation	10   30   100 Lux (24H) – Adjustable
Time Adjustment	10seg   1,5   5   15min
Ideal Installation Height	1.5m – 3.5m ceiling   2m - 3m wall
Application	Ceiling and wall
Measures	Ø300mm
Certification	CE
Globe Material	PC

Detection Area

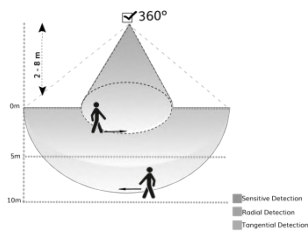

Wiring Diagram

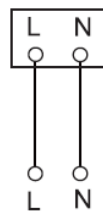

Technical Drawing

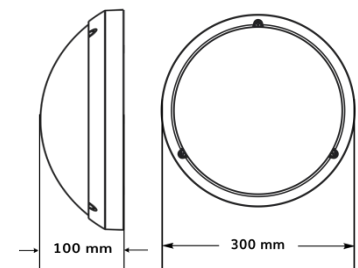

Detection Diagram

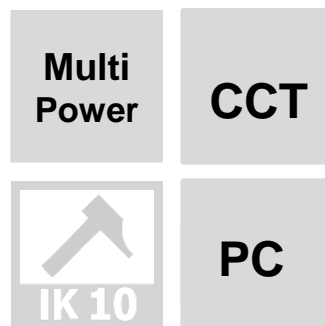
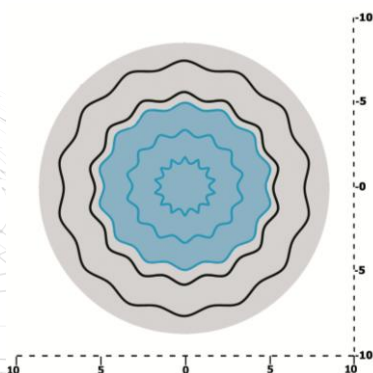

Technical Summary



Product Code



# Lighting





08

## Projectors with and without sensors

iMSL Eris Led 10W WHI - 072129

iMSL Eris Led 10W BLK - 072136

iMSL Saturno Led 20W WHI - 072013 APP

iMSL Saturno Led 20W BLK - 072020 APP

iMSL Saturno Led 30W WHI - 072037 APP

iMSL Saturno Led 30W BLK - 072044 APP

iMSL Multi Mercury 20W WHI - 072549 V2

iMSL Multi Mercury 20W BLK - 072556 V2

iMSL Multi Mercury 30W WHI - 072563 V2

iMSL Multi Mercury 30W BLK - 072570 V2

iMSL Multi Mercury 50W WHI - 072587 V2

iMSL Multi Mercury 50W BLK - 072594 V2

iMSL Multi Mercury 100W WHI - 072822

iMSL Multi Mercury 100W BLK - 072839

iMS 160° Multi Mercury WHI - 072600

iMS 160° Multi Mercury BLK - 072617

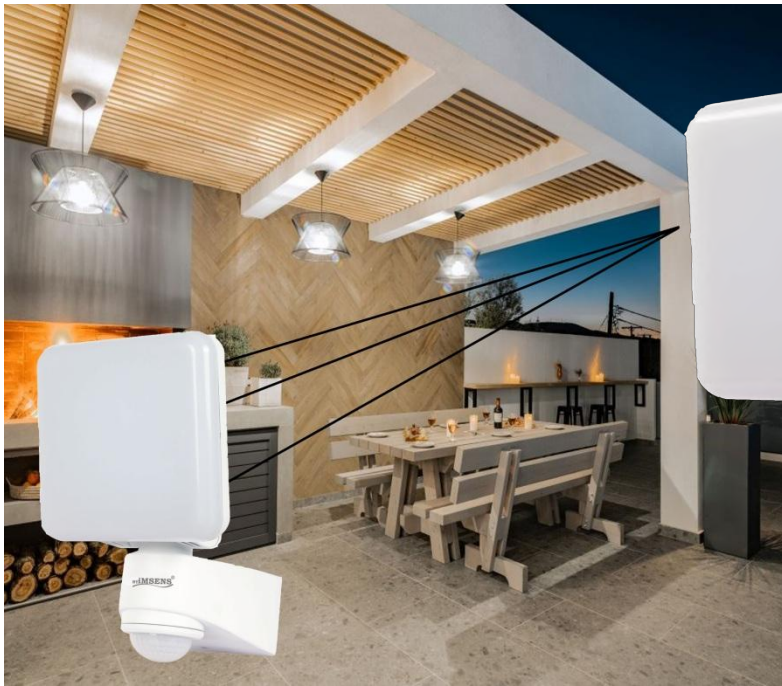

Universal Range  
★★★★★



## iMSL Eris Led 10W WHI / BLK

LED projector with infrared sensor for wall mounting.

The Eris Spotlight with infrared sensor combines high-quality sensor technology with LED lighting. The system consistently demonstrates that efficiency is a matter of technology: precisely 100% LED light, yet only a third of the energy consumption compared to halogen spotlights.

The Eris LED 10W Floodlight is equipped with 360° PIR technology that detects the invisible heat emitted by moving objects (people, animals, etc.). The heat is detected and electronically converted into a signal that switches on the floodlight. Heat is not detected through obstacles such as walls or glass panels. This sensor constantly monitors the pre-defined operating zone and immediately switches the light on when it detects movement in that area. This means that whenever movement is detected within the sensor's range, the light switches on automatically to illuminate paths, steps, patios, balconies or any selected area, for safety or convenience. As long as there is movement within the sensor's range, the light will remain on.

Its versatility, allowing the beam to rotate 360° horizontally and 90° vertically, enables easy installation.

This floodlight is manufactured to high-quality and performance standards, designed to achieve maximum energy efficiency whilst respecting the environment throughout its manufacturing process.

The floodlight is made from UV-resistant plastic, ensuring greater durability.



PIR



10W



LM  
900lm



K  
5000K



360°



12m



3-2000lux



10s-10min



IP  
54



IK05



## Technical Summary

White Product Code	iMSL Eris Led 10W WHI - 072129
Black Product Code	iMSL Eris Led 10W BLK - 072136
Sensor Type	Infrared
Power	10W
Lumens	900lm
Kelvin	5000K
Voltage	220V/AC-240V/AC / 50HZ
Detection Angle	360°
Detection Range	Max. 12m
Type of Protection	IP54 / IK05
Twilight Regulation	3 - 2000Lux (Adjustable)
Time Adjustment	10seg a 10min
Ideal Installation Height	1.8m - 8m
Application	Wall
Measures	230mm x 140mm
Certification	CE

Detection Area

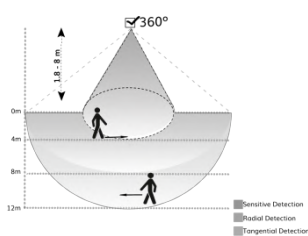

Wiring Diagram

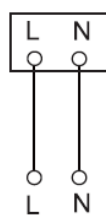

Technical Drawing

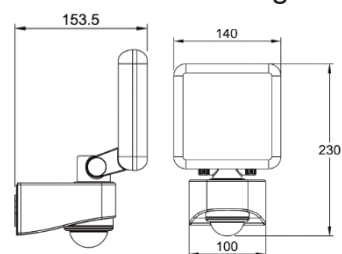

Detection Diagram

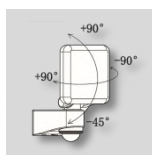
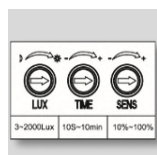
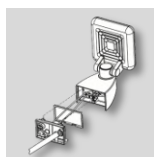
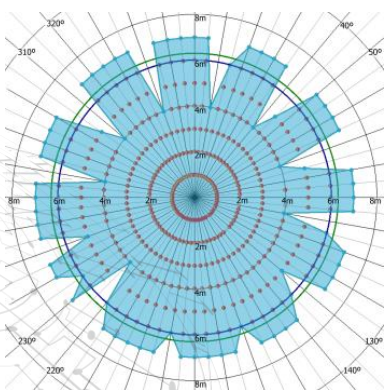

Technical Summary



White



Black

Product Code



White



Black



Multi-PRO Range  
★★★★★



## iMSL Saturno Led 20W/30W WHI / BLK

LED projector with infrared sensor for wall mounting.

The Saturno spotlight with infrared sensor combines highly reliable sensor technology with LED lighting. The system consistently demonstrates that efficiency is a matter of technology: precisely 100% LED light, but only a third of the energy consumption compared to halogen spotlights. The energy savings are significant, and the convenience provided by automated lighting control is made possible by the combination of a sensor system with LED lighting. The 20W or 30W Saturn LED floodlight with PIR technology constantly monitors the pre-defined operating area and immediately switches the light on when it detects movement within that area. This means that whenever movement is detected within the sensor's range, the light switches on automatically to illuminate paths, steps, patios, balconies or any selected area, for safety or convenience. As long as there is movement within the sensor's range, the light will remain on.

It works with potentiometers and via Bluetooth with the BYiMSENS® app. Through the app, you can control the floodlight, switch it on permanently, switch it off, adjust settings, etc. Its versatility, allowing the beam to rotate 360° horizontally and 90° vertically, enables easy installation.

It is the ideal product for monitoring land, factories and outdoor facilities, medium-sized façades, homes, outdoor leisure areas, amongst others. Its protection rating safeguards it against the elements.

This projector is manufactured to exacting standards of quality and performance, with the aim of achieving maximum energy efficiency whilst ensuring that its manufacturing process is environmentally friendly.



## Technical Summary

White Product Code	iMSL Saturno Led 20W WHI - 072013 APP iMSL Saturno Led 30W WHI - 072037 APP
Black Product Code	iMSL Saturno Led 20W BLK - 072020 APP iMSL Saturno Led 30W BLK - 072044 APP
Sensor Type	Infrared
Power	20W / 30W
Lumens	1440lm / 2160lm
Kelvin	5000K
Voltage	220V/AC-240V/AC / 50HZ
Detection Angle	130°
Detection Range	Max. 10m
Type of Protection	IP44 / IK07
Twilight Regulation	0 - 100Lux (Adjustable)
Time Adjustment	10seg a 4min
Ideal Installation Height	1.8m - 8m
Application	Wall
Measures	190mm x 179mm
Certification	CE

### Detection Area

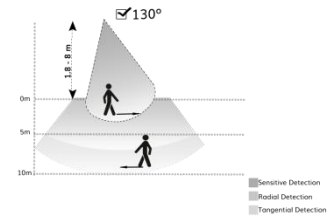

### Detection Diagram

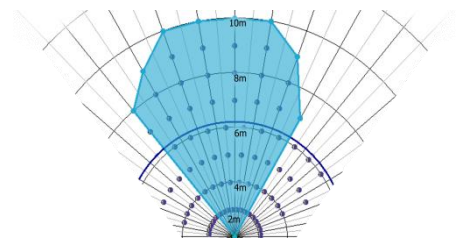

### Wiring Diagram

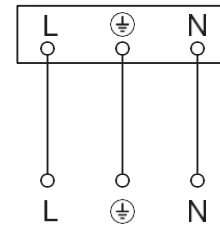

### Technical Drawing

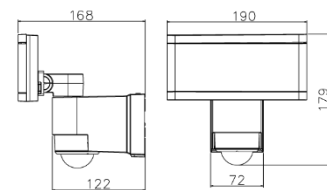

#### Technical Summary



White 20W

#### Product Code



#### Technical Summary



White 30W



Black 20W



Black 30W

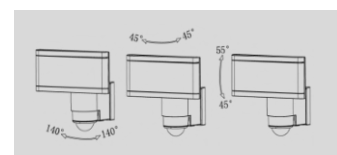
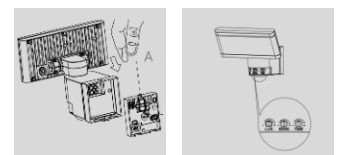



Multi-PRO Range  
★★★★★



## iMSL Multi Mercury 20/30/50/100W WHI/BLK

LED spotlight for wall mounting. Can be fitted with the iMS 160° Multi Mercury sensor.

The Multi Mercury Floodlight is a cast aluminium floodlight with an electrostatic powder-coated finish (as are its accessories). It features a heat sink, which helps to maintain the quality and longevity of its LEDs, thereby ensuring greater cost-effectiveness. It is available in white and black. It can be operated with or without a sensor (accessory). It is ideal for lighting both small and large areas, thanks to the 4 power levels available: 20W/30W/50W and 100W. It includes a wall-mount bracket that allows the floodlight to rotate 180° on its axis, both vertically and horizontally. It allows you to select the light temperature: 3000K (warm white), 4000K (natural white) and 6000K (cool white). It is therefore suitable for all needs.

The floodlight has an accessory that enables motion detection using infrared technology. This is the iMS 160° Multi Mercury sensor, which is sold separately: reference 072600 (white) and 072617 (black).

It can be used both indoors and outdoors thanks to its high protection rating (IP65), which protects it from the elements.

It is a floodlight manufactured to exacting standards of high quality and performance, designed to achieve maximum energy efficiency whilst respecting the environment throughout its manufacturing process.

It is the ideal product for monitoring land, factories and outdoor facilities, building facades, homes, outdoor leisure areas, and more.

  
20W/30W  
50W/100W

**LM**  
2200lm/3300lm  
5500lm/11000lm

  
3000K  
4000K  
6000K  
CCT

  
30 000H

**IP**  
65

  
IK07

## Technical Summary - 20W

White Product Code	iMSL Multi Mercury 20W WHI - 072549 V2
Black Product Code	iMSL Multi Mercury 20W BLK - 072556 V2
Power	20W
Lumens	2200lm – 110lm/W
Kelvin	3000K / 4000K / 6000K
Voltage	220V/AC-240V/AC / 50HZ
Type of Protection	IP65 / IK07
Application	Wall and Ceiling
Measures	135mm x 85mm
Certification	CE

Technical Summary



White



Black

Product Code



White



Black

## Technical Summary - 30W

White Product Code	iMSL Multi Mercury 30W WHI - 072563 V2
Black Product Code	iMSL Multi Mercury 30W BLK - 072570 V2
Power	30W
Lumens	3300lm – 110lm/W
Kelvin	3000K / 4000K / 6000K
Voltage	220V/AC-240V/AC / 50HZ
Type of Protection	IP65 / IK07
Application	Wall and Ceiling
Measures	135mm x 85mm
Certification	CE

Technical Summary



White



Black

Product Code



White



Black

## Technical Summary - 50W

White Product Code	iMSL Multi Mercury 50W WHI - 072587 V2
Black Product Code	iMSL Multi Mercury 50W BLK - 072594 V2
Power	50W
Lumens	5500lm – 110lm/W
Kelvin	3000K / 4000K / 6000K
Voltage	220V/AC-240V/AC / 50HZ
Type of Protection	IP65 / IK07
Application	Wall and Ceiling
Measures	165mm x 105mm
Certification	CE

Technical Summary



White



Black

Product Code



White



Black

## Technical Summary - 100W

White Product Code	iMSL Multi Mercury 100W WHI - 072822
Black Product Code	iMSL Multi Mercury 100W BLK - 072839
Power	100W
Lumens	11000lm – 110lm/W
Kelvin	3000K / 4000K / 6000K
Voltage	220V/AC-240V/AC / 50HZ
Type of Protection	IP65 / IK07
Application	Wall and Ceiling
Measures	280mm x 180mm
Certification	CE

Technical Summary



White



Black

Product Code



White



Black

## Technical Drawing - 20W

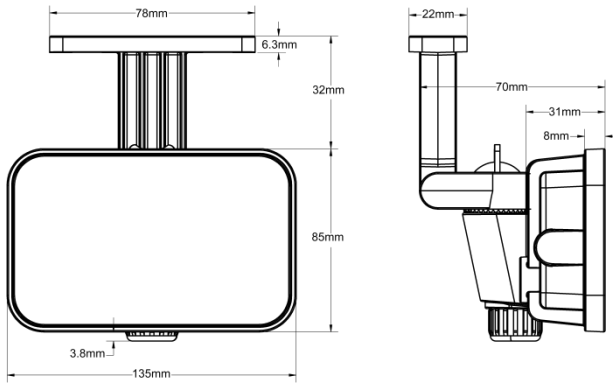

## Technical Drawing - 30W

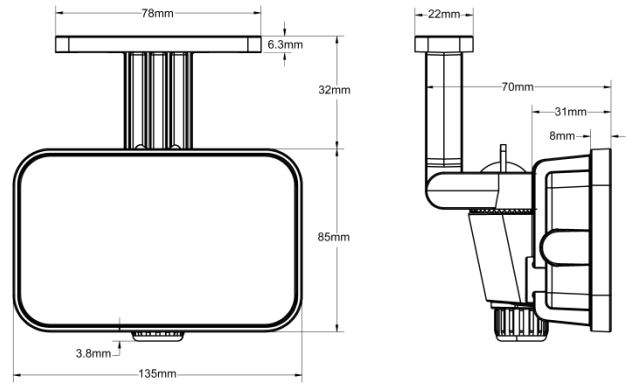

## Technical Drawing - 50W

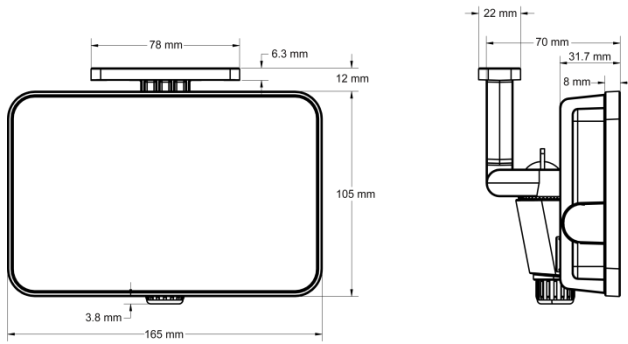

## Technical Drawing - 100W

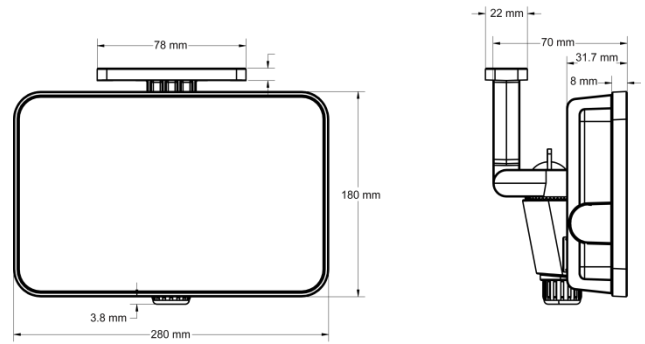

## Wiring Diagram

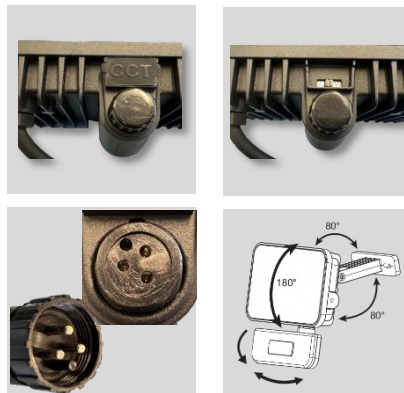
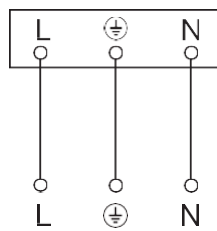



Multi-PRO Range



## iMS 160° Multi Mercury WHI / BLK

Motion detector with infrared sensor, available in white and black for use as an accessory with the Mercury 20W/30W/50W/100W spotlights.

The sensor can be oriented 360°. The detection range can be adjusted as desired, but the orientation of the movement in the detection field has a great influence on the sensitivity. It is a motion sensor with 160° PIR technology that detects through the invisible heat emitted by moving objects (people, animals, etc.). The heat is detected and electronically converted into a signal that turns on the projector. Heat is not detected through obstacles such as walls or glass panels. This sensor constantly monitors the predefined operating zone and immediately turns on the light when it detects movement in that area. This means that whenever movement is detected within the sensor's range, the light automatically turns on to illuminate paths, steps, patios, balconies, or any selected area, for safety or convenience reasons.

It is the ideal item for monitoring land, factories, and outdoor facilities, among others. It allows for use both indoors and outdoors due to its high degree of protection (IP65) which protects it against the elements.

It is a detector manufactured under demanding standards of high quality and performance, in order to achieve maximum energy efficiency, respecting the environment in its manufacturing process.

The detector is manufactured with UV-resistant plastic, thus allowing for greater durability.



## Technical Summary

White Product Code	iMS 160° Multi Mercury WHI – 072600
Black Product Code	iMS 160° Multi Mercury BLK - 072617
Sensor Type	Infrared
Lens Type	Multi-lens – emits a greater number of beams per square metre
Power	100W
Voltage	220V/AC-240V/AC / 50HZ
Detection Angle	160°
Detection Range	Max. 13m
Type of Protection	IP65
Twilight Regulation	10 - 2000Lux (Adjustable)
Time Adjustment	10seg a 7min
Ideal Installation Height	1.8m - 8m
Application	Wall
Measures	110mm x 37.6mm
Certification	CE

### Detection Area

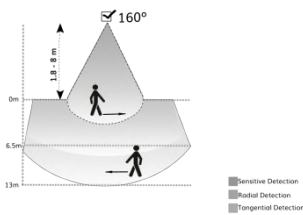

### Technical Drawing

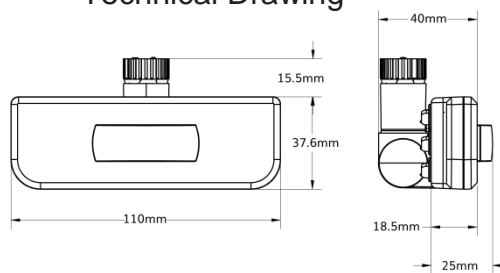

### Detection Diagram

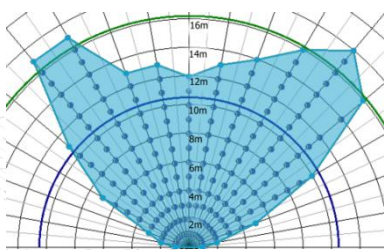

### Technical Summary



White



Black

Product Code



White



Black

# Lighting



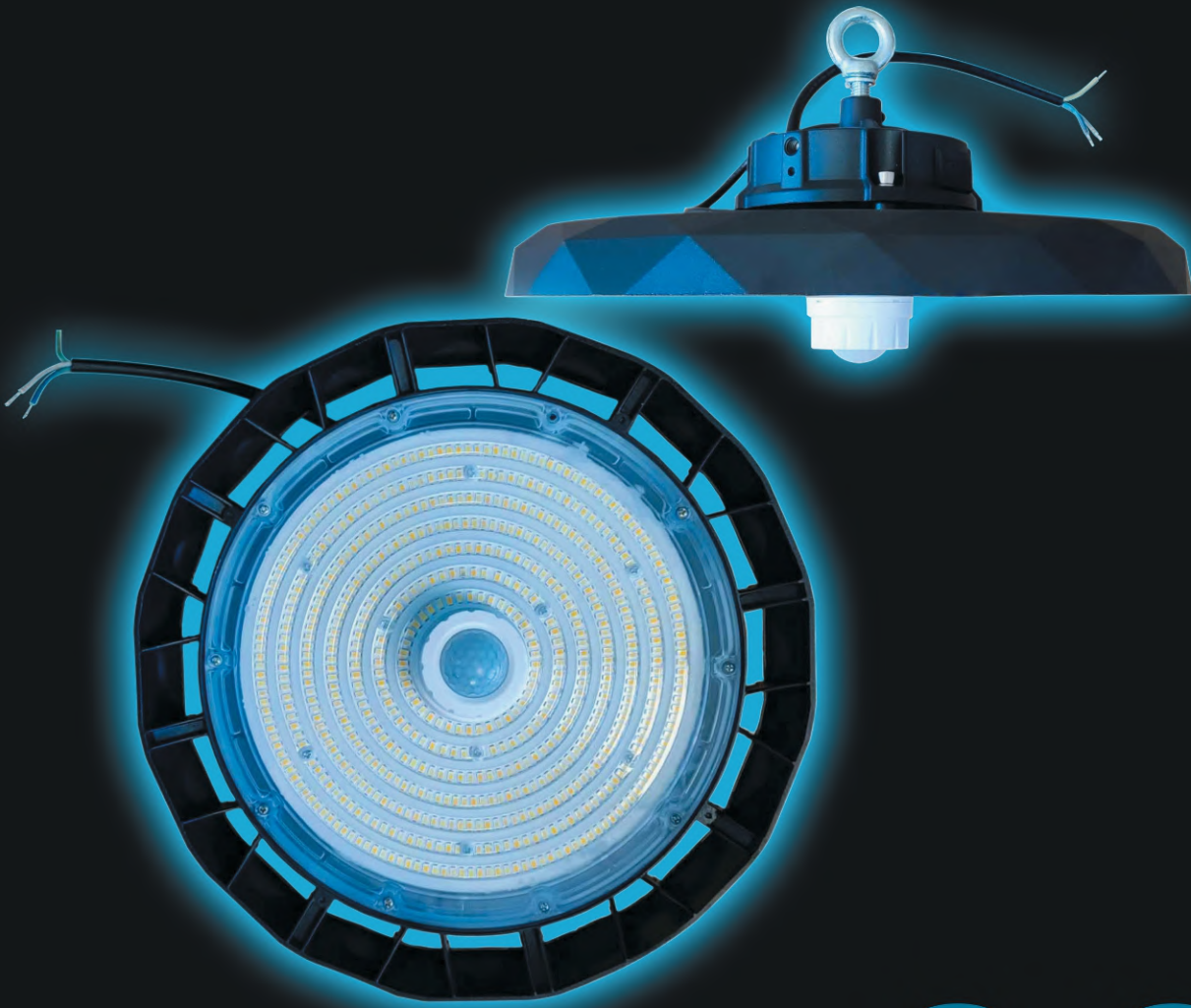

09.

# Highbay Lighting

iMSL Multi Earth 90W -> 150W BLK - 072723

iMS 360° Multi Earth WHI - 072730 iC



Multi-PRO Range  
★★★★★

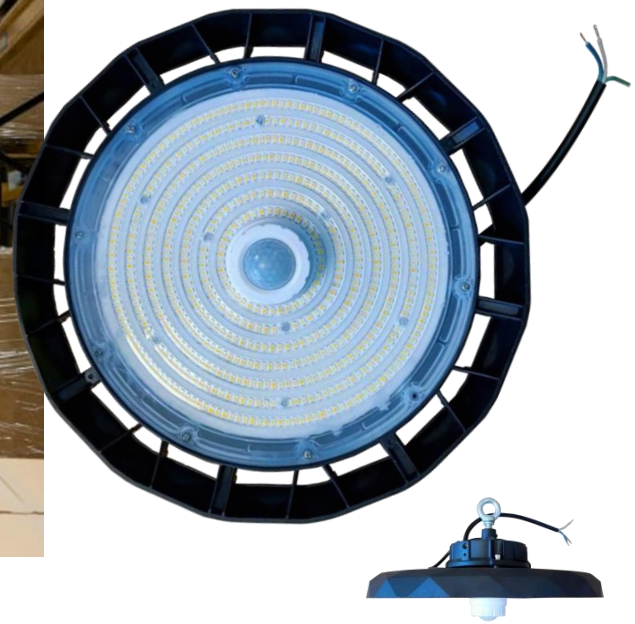

## iMSL Multi Earth 90W -> 150W BLK

LED Highbay ceiling light. Can be fitted with the iMS 360° Multi Earth sensor.

The Multi Earth highbay intelligent lighting system is designed to provide the necessary and homogeneous light in large areas and at great heights.

Its ergonomic design makes the product discreet. It is extra-flat and lightweight, allowing for easy and quick installation.

Technologically, the product allows for the definition of the lighting color (CCT), as well as the lighting power, directly on the item. It has a high degree of protection (IP65) that protects it against the elements.

It allows the use of the iMS 360° Multi Earth WHI - 072730 iC sensor (with infrared technology) (sold separately), thus becoming a complete and ideal item for warehouses, industrial buildings, large surfaces, workshops, sports and recreational areas, supermarkets, or any other place where there is a need to provide perfect lighting that can be installed in a location with a high ceiling. The detector is programmed using the RC5 remote control (sold together with the detector), which makes it even easier to use.

It is a bell-shaped structure manufactured under demanding high quality and performance standards, in order to achieve maximum energy efficiency, while respecting the environment in its manufacturing process.



LM  
150lm/W



IP  
65



## Technical Summary

Product Code	iMSL Multi Earth 90W ->150W BLK - 072723
Power	90W/120W/150W
Lumens	150lm/W
Kelvin	3000K / 4000K / 6000K
Voltage	AC100-277V, 50/60Hz
Type of Protection	IP65 / IK10
Protection Class	I
Ideal Installation Height	12m
Application	Ceiling
Measures	Ø295mm
Certification	CE

Wiring Diagram

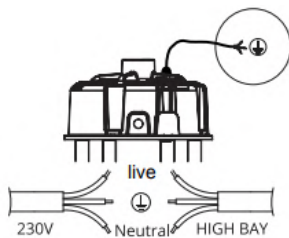

Technical Drawing

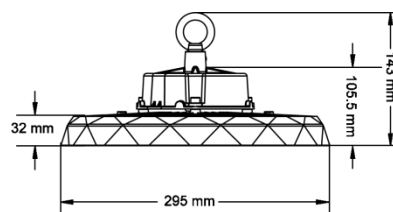

Technical Summary



Product Code





Multi-PRO Range  
★★★★★



## iMS 360° Multi Earth WHI

Infrared motion detector, for use as an accessory in the iMSL Multi Earth 90W -> 150W BLK.

Infrared motion detector for use as an accessory in the iMSL Multi Earth 90W -> 150W BLK.

The infrared motion sensor allows for energy savings and greater sustainability. It has an IP65 protection rating, perfect for outdoor and indoor use, exposed to humidity and high temperatures. It also includes a quick connector for easy and convenient installation, specifically for use in the iMSL Multi Earth 90W -> 150W BLK.

A remote control (RC5) is supplied with this sensor, allowing you to parameterize various points: ON/OFF, reset the detection range parameters, adjust the ambient light parameter in relation to the detection or deactivate it, as well as its timing after the last movement.

It is a detector manufactured under high quality and performance standards, in order to achieve maximum energy efficiency, respecting the environment in its manufacturing process.

It is manufactured with UV-resistant plastic, thus allowing for greater durability.



## Technical Summary

Product Code	iMS 360° Multi Earth WHI - 072730 iC
Sensor Type	Infrared
Voltage	12 VDC
Detection Angle	360°
Detection Range	8m
Type of Protection	IP65 / IK07
Twilight Regulation	2   10   50 Lux (24H) - Adjustable
Time Adjustment	5 seg a 10min
Ideal Installation Height	12m
Application	Ceiling
Certification	CE
Command	Includes command iMS RC5 - 072747

Detection Area

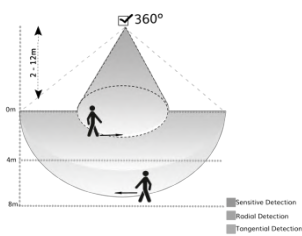

Technical Drawing

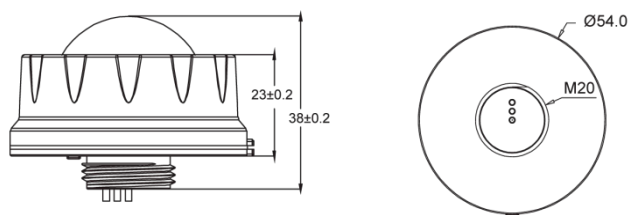

Detection Diagram

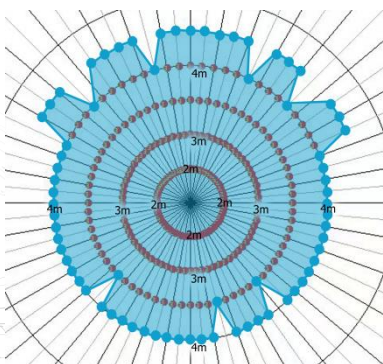

Technical Summary



Product Code



# Heat Guns, Glue Gun and Screwdriver



**iMTOOLS®**

## Pictogram Legend



Maximum engine power

---



Voltage

---



Thermal element material type

---



Thermal element material type

---



Air flow rate

---



Temperature

---



Glue sticks

---



Battery voltage

---



Wrist rotation

---



Charge level indicator

---



Soft handle

---



LED indicator light

---



Rotations per minute

---



Reversible

---

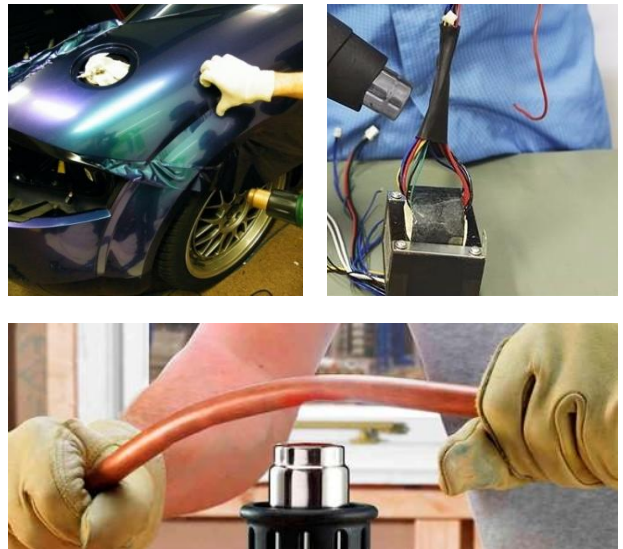

## iMT AG 2000

Hot air blower with two heating and airflow settings for most indoor and outdoor jobs.

The blower is designed to facilitate paint stripping, pipe handling and work, PVC shrinking, plastic welding and bending, as well as for general drying and defrosting purposes. The air temperature can be adjusted to suit a wide range of applications.

Program I: Facilitates work performed at maximum temperatures up to 450° and at an air flow of up to 300 l/min.

Program II: Enables work up to 600° temperature and an air flow of 500 l/min. This blower has an ergonomic, lightweight design with a handle guard, designed primarily for DIY work that does not require continuous hours of operation, as its heating element is made of mica.

In order to complement and facilitate the execution of precise work, there is a set of accessories that can be attached.



MICA



## Technical Summary

Product Code	iMT AG 2000 - 072181
Power	2000W
Voltage	220-240V AC
Temperature Regulation	2 Levels
Levels	I, II
Temperature	I – 450°C / II – 600°C
Air flow	300l/min / 500l/min
Thermal element	Mica
Durability of the thermal element	100 hours
Power cable length	200cm
Measures	23.5cm x 8.5cm x 24cm
Certification	CE

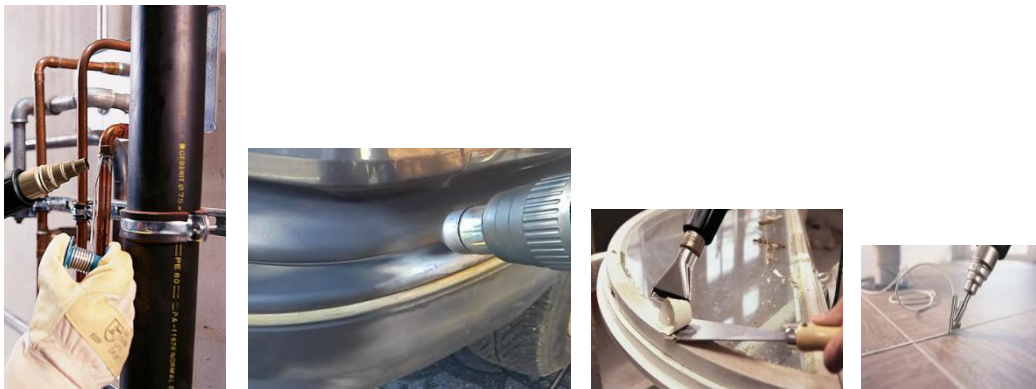

## Accessories



Technical Summary



Product Code



5 600244 072181 >

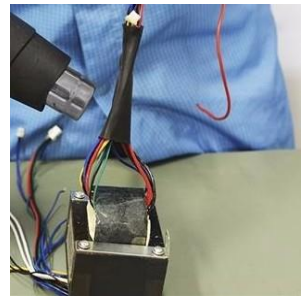

## iMT AG 2000 E

Powerful, electronically controlled hot air blower with temperature regulation independent of airflow regulation.

Professional tool made with high-quality raw materials for virtually all hot air applications. The temperature and airflow control switch is conveniently operated on the handle, using only one hand.

The blower is designed to facilitate paint stripping, pipe handling and work, PVC shrinking, plastic welding and bending, copper and tin soldering, as well as for general drying and defrosting purposes.

The air temperature can be adjusted to suit a wide range of applications.

It has 3 distinct programs:

Program I - Used for work up to 50°C. The airflow regulation is 250 l/min.

Program II - Facilitates work performed at temperatures between 50 and 600 °C. The airflow regulation allows a flow rate of 250 l/min and is independent.

Program III - Enables work with temperatures up to 600°C. Airflow regulation allows for a flow rate of 500 l/min.



CERAMIC



## Technical Summary

Product Code	iMT AG 2000 E - 072198
Power	2000W
Voltage	220-240V AC
Temperature Regulation	7 phases
Levels	I, II, III
Temperature	I – 50°C / II – 50-600°C / III – 50-600°C
Air flow	250l/min / 500l/min
Thermal element	Ceramic
Durability of the thermal element	650 hours
Power cable length	200 cm
Measures	29cm x 9.2cm x 26.8cm
Certification	CE



## Accessories



Technical Summary



Product Code



5 600244 072198 >

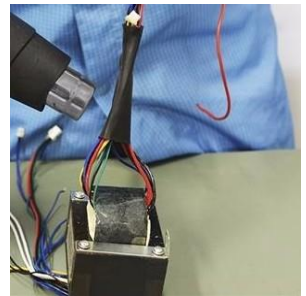

## iMT AG 2000 LCD

Top-of-the-range microprocessor-controlled hot air blower with temperature regulation on the LCD display and airflow control.

It is the top of the range in terms of versatility, durability and ergonomics. The extremely high power reserves, strong airflow and high-quality raw materials exceed all expectations. The LCD display is integrated into the back, so it is always visible.

The blower is designed to facilitate paint stripping, pipe handling and work, PVC shrinking, plastic welding and bending, work with leather, synthetic materials and all materials that require precise regulation of airflow and temperature, as well as for general drying and defrosting purposes.

The air temperature can be adjusted to suit a wide range of applications. The blower has an LCD and a touch selector. Next to the display there are 6 adjustment buttons. Two of the buttons allow temperature oscillation. Two other buttons allow you to increase or decrease the airflow and the other two are for setting the memories.



CERAMIC



- 1: 150°C
- 2: 200°C
- 3: 300°C
- 4: 400°C

## Technical Summary

Product Code	iMT AG 2000 LCD - 072204
Power	2000W
Voltage	220-240V AC
Temperature Regulation	4 memorizable programs
Levels	I, II
Temperature	I – 50°C / II – 50-650°C
Air flow	250-500l/min / 250-500l/min
Thermal element	Ceramic
Durability of the thermal element	650 hours
Power cable length	200 cm
Measures	29cm x 9.2cm x 26.8cm
Certification	CE



## Accessories



Technical Summary



Product Code



5 600244 072204 >



## iMT GG 100

Electronically controlled glue gun, economical and with high fusion capacity for both DIY and professional use.

This glue gun is designed for gluing various surfaces, such as wood, plastics, foam, fabrics, paper, cardboard, ceramics, electrical cables, etc.

Its ease of use makes this device the right choice for those who need to work perfectly.

Product advantages: high fusion capacity, possibility of replacing nozzles, support stand for the gun when not in use.

It has overheat protection, preventing overheating of the fuse installed near the heating components.

It has 1 on/off button with a safety indicator light.

It allows for the replacement of the glue outlet nozzles after they wear out (accessory sold separately).

Ergonomic, compact and solid body, made of heat-resistant and anti-vibration plastics.



100W



220-240V



100-200°C



11.2mm  
14-30g/min

## Technical Summary

Product Code	iMT GG 100 - 072297
Power	100W (Max 300W)
Voltage	220-240V AC
Warm-up Period	3 – 5 min
Definite Time	10 – 20 seg
Melting Temperature	80°C
Operating Temperature	100 – 200°C
Glue debt	14 – 30 gr/min
Measures	23.5cm x 8.5cm x 24cm
Certification	CE



## Accessories

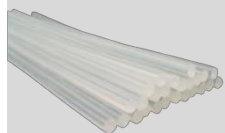

iMT GG GLue Sticks 11.2mm diam | 20cm long | 1kg – 072327

Ø 11.2mm / 20cm length / 1kg / Material: mixture of ethylene vinyl acetate 60-80% / copolymers / hydrocarbon resin hidrogenada



iMT GG Nozzle 3mm diam | 5cm long – 072303

Ø3mm 5cm length / material: copper



iMT GG Nozzle 2mm diam | 4.5cm long – 072310

Ø2mm / 4.5cm length / material: copper

Technical Summary



Product Code





## iMT CS 3.6V KIT

A cordless screwdriver ideal for any application, as its rotation facilitates various modes of use.

Cordless screwdriver with ergonomic design, integrated LED light, left and right rotation for screwing and unscrewing, and can be transformed from a tubular screwdriver to a pistol-grip screwdriver.

Thanks to the modern lithium-ion battery, weight reduction is achieved and the battery can be recharged at any time without loss of capacity.

The ease of use makes this device the right choice for those who need to work perfectly.

With a lightweight handle, adjustable 180° to any work area. It contains an LED to illuminate the work area.

iMTOOLS cordless screwdrivers are not only powerful, but also set standards in terms of size and weight. They impress thanks to their ideal weight, robustness and long battery capacity.

3,6V  
Li-ion

SOFT  
GRIP



180°  
Ajust.180

3 - LED

RPM  
230rpm

## Technical Summary

Product Code	iMT CS 3.6V KIT - 072372
Weight	0.35 Kg / 1.25Kg
Supply Voltage	3.6V Li-ION
Charge level indicator	Yes – LED – 3 stages
Speed	230 rpm
Maximum strength	4.5Nm
Loading Time	3 – 5 hours
Adjustable Wrist	Rotating 180°
Suitcase	Includes accessories (45 pieces)
Certification	CE

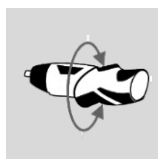
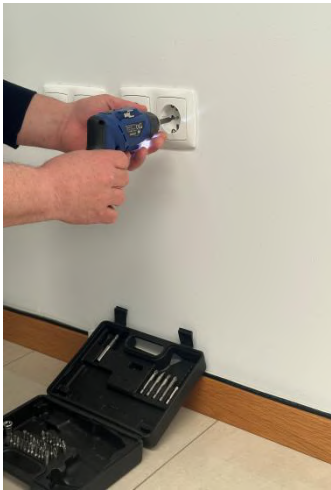

Technical Summary Product Code



5 600244 072372 >



***niko***









## DALI-2 Detectors

Article	Installation	Detection Angle	Detection Range	Installation height	Twilight Regulation	Time adjustment	Zones*	Number of DALI devices	IP	Blue-tooth
 <b>353-650321</b> Presence detector P47MR, DALI-2, master	Built-in	360°	12m	2 - 3.5m	20 -2000 lux, ∞	30s - 2h ∞	3	64	IP20	Yes
 <b>353-651321</b> Presence detector P47MR, DALI-2, master, (SnapFit)	Built-in	360°	12m	2 - 3.5m	20 - 2000 lux, ∞	30s - 2h ∞	3	64	IP20	Yes
 <b>353-651421</b> Presence detector P48MR, DALI-2, Master, SnapFit	Built-in	360°	12m	2 - 3.5m	20 - 2000, lux, ∞	30s - 2h ∞	4	64	IP20	Yes
 <b>353-652321</b> Presence detector P47MR, DALI-2, master	Salient	360°	12m	2 - 3.5m	20 - 2000 lux, ∞	30s - 2h ∞	3	64	IP54	Yes
 <b>353-750321</b> Presence detector P47LR, DALI-2, master	Built-in	360°	37m	2 - 3.5m	20 - 2000 lux, ∞	30s - 2h ∞	3	64	IP20	Yes
 <b>353-751321</b> Presence detector P47LR, DALI-2, master (SnapFit)	Built-in	360°	37m	2 - 3.5m	20 - 2000 lux, ∞	30s - 2h ∞	3	64	IP20	Yes
 <b>353-752321</b> Presence detector P47LR, DALI-2, master	Salient	360°	37m	2 - 3.5m	20 - 2000 lux, ∞	30s - 2h ∞	3	64	IP54	Yes
 <b>353-652421</b> Presence detector P48MR, DALI-2, master	Salient	360°	12m	2 - 3.5m	20 - 2000 lux, ∞	30s - 2h ∞	4	64	IP54	Yes
 <b>353-751421</b> Presence detector P48LR, DALI-2, master (SnapFit)	Built-in	360°	37m	2 - 3.5m	20 - 2000 lux, ∞	30s - 2h ∞	4	64	IP20	Yes
 <b>353-752421</b> Presence detector P48LR, DALI-2, master	Salient	360°	37m	2 - 3.5m	20 - 2000 lux, ∞	30s - 2h ∞	4	64	IP54	Yes
 <b>353-852411</b> Motion detector M48HC, DALI-2, master	Salient	360°	53m	4 - 12m	20 - 2000 lux, ∞	30s - 2h ∞	4	64	IP54	Yes











## DALI-2 Detectors

Article	Installation	Detection Angle	Detection Range	Installation height	Twilight Regulation	Time adjustment	Zones*	Number of DALI devices	IP	Blue-tooth
 <b>353-650021</b> Presence detector P46MR, DALI-2, Slave - BMS	Built-in	360°	12m	2 - 3.5m	0 – 10360 lux	-	-	-	IP20	Yes
 <b>353-651021</b> Presence detector P46MR, DALI-2, Slave - BMS, (SnapFit)	Built-in	360°	12m	2 - 3.5m	0 – 10360 lux	-	-	-	IP20	Yes
 <b>353-652021</b> Presence detector P46MR, DALI-2, Slave - BMS	Salient	360°	12m	2 - 3.5m	0 – 10360 lux	-	-	-	IP54	Yes
 <b>353-750021</b> Presence detector P46LR, DALI-2, Slave - BMS	Built-in	360°	37m	2 – 3.5m	0 – 10360 lux	-	-	-	IP20	Yes
 <b>353-751021</b> Presence detector P46LR, DALI-2, Slave – BMS (SnapFit)	Built-in	360°	37m	2 – 3.5m	0 – 10360 lux	-	-	-	IP20	Yes
 <b>353-752021</b> Presence detector P46LR, DALI-2, Slave - BMS	Salient	360°	37m	2 – 3.5m	0 – 10360 lux	-	-	-	IP54	Yes
 <b>353-852011</b> Motion detector M46HC, DALI-2, Slave - BMS	Salient	360°	53m	4 – 12m	0 – 10360 lux	-	-	-	IP54	Yes

\*Lighting Switching Zones

## KNX Detectors

Article	Installation	Detection Angle	Detection Range	Installation height	Twilight Regulation	Time adjustment	Lighting Switching Zones	IP
 <b>350-34001</b> Presence detector KNX®, 5 channels, 7-8 m, IP54, mini	Built-in	360°	8m	2 - 4m	10 - 2000 lux	1s - 18h	5	IP54
 <b>350-34002</b> Presence detector P34MR, KNX®, 5 channels	Built-in	360°	10m	2 - 4m	10 - 2000 lux	30s - 18h	5	IP44
 <b>350-34003</b> Motion detector M34LR KNX®, 5 channels	Built-in	360°	41m	2 - 3m	10 - 2000 lux	30s - 18h	5	IP40
 <b>350-34013</b> Motion detector M34LR KNX®, 5 channels	Built-in	360°	41m	2 - 3m	10 - 2000 lux	30s - 18h	5	IP40
 <b>350-34004</b> Motion detector M34HC KNX®, 5 channels	Built-in	360°	20m	4 - 10m	10 - 2000 lux	30s - 18h	5	IP20
 <b>350-34014</b> Motion detector M34HC KNX®, 5 channels	Built-in	360°	20m	4 - 10m	10 - 2000 lux	30s - 18h	5	IP20
 <b>350-530311</b> Motion detector KNX®, 2 channels	Salient	360°	40m	2 - 2.5m	10 - 2000 lux	30s - 1h	2	IP20
 <b>350-213001</b> Motion detector KNX®, 5 channels	Salient	360°	32m	2 - 3m	5 - 2000 lux	5s - 1h	5	IP55



BYiMSENS®

[byimsens@byimsens.com](mailto:byimsens@byimsens.com)

[byimsens.com](http://byimsens.com)

BY062026PROV2